



NEC



e228
product manual

- Windows® XP and Windows® 2000 are registered trademarks of Microsoft Corporation in the United States and/or other countries.
- This product contains ACCESS Co., Ltd.s NetFront3 Internet browser software. 
- NetFront3 is the trademark or registered trademark of ACCESS Co., Ltd. in Japan and in other countries.
- A portion of this software includes software modules developed by the Independent JPEG Group.
You may not alter or reproduce, or remove from this product the Internet browser software contained herein.
- Use of the GIF decoder module contained in this product is permitted only as a part of browser software, under a license from Unisys Corporation. For other use, you have to obtain a separate license from Unisys Corporation.
- Purchase and/or use of the browser software contained in this product does not authorise your use of any other product or performance of any other method or activity involving use of the LZW patents or GIF technology, unless you are separately licensed in writing by Unisys Corporation.
- Java and all Java-based marks are trademarks or registered trademarks of Sun Microsystems, Inc. in the U.S. and other countries.
- T9® Text Input is a registered trademark of Tegic Communications Inc.
- T9 Text Input is licensed under one or more of the following: U.S. Pat. Nos. 5,818,437, 5,953,541, 5,187,480, 5,945,928, 6,011,554, and 6,307,548; Australian Pat. No. 727539; Canadian Pat. No. 1,331,057; United Kingdom Pat. No. 2238414B; Hong Kong Standard Pat. No. HK0940329; Republic of Singapore Pat. No. 51383; Euro.Pat. No. 0 842 463 (96927260.8) DE/DK, FI, FR, IT,NL,PT,ES,SE,GB; Republic of Korea Pat. Nos. KR201211B1 and KR226206B1; and additional patents are pending worldwide.
- Licensed by QUALCOMM Incorporated under one or more of the following United States Patents and/or their counterparts in other nations: 4,901,307, 5,490,165, 5,056,109, 5,504,773, 5,101,501, 5,506,865, 5,109,390, 5,511,073, 5,228,054, 5,535,239, 5,267,261, 5,544,196, 5,267,262, 5,568,483, 5,337,338, 5,600,754, 5,414,796, 5,657,420, 5,416,797, 5,659,569, 5,710,784, and 5,778,338.
- WOW, Dialog Clarity, SRS and  symbol are trademarks of SRS Labs, Inc. 
- WOW and Dialog Clarity technologies are incorporated under license from SRS Labs, Inc.
- "The James Bond Theme" by Monty Norman© EMI Unart Catalog Inc.(BMI) All Rights Reserved. International Copyright Secured. Used by permission."
- The specifications and information in this manual are subject to change without notice.
- Some contents in this manual may not apply to your phone depending upon the software of the phone or your service provider.

Important Safety Information

Emergency services

To make an emergency call in any country

- 1 Ensure that your e228 is switched on and in service.
- 2 Press the **Start** key to return to the Home screen if needed.
- 3 Press **112** (or **999** within the UK or **000** in Australia) followed by the **Start** key. (When the USIM card is not inserted or when the dial lock function is on, press the **SK2 (Emrgy)**. When the dial lock function is on, press **112** and **SK1 (Yes)**. Refer to **Locking your e228** section on page 28 for further instructions on emergency calls when the key lock is on.)

Follow the instructions and do not end the call until told to do so.

 Tell the operator which service you require: Police, Ambulance, Fire Brigade, Coastguard or Mountain Rescue Service. Give your location and, if possible, remain where you are to maintain contact.

 The 112 emergency number service is available on every digital network service. Alternatively, use 999 in the UK, or 000 in Australia. Note that these can only be used with a valid USIM.

 Due to the nature of the cellular system, connection to emergency calls cannot be guaranteed.

General care

A phone contains delicate electronic circuitry, magnets and battery systems. You should treat it with care and pay attention to the following:

- This phone is fitted with an internal battery that can only be replaced by a qualified service engineer. There is a risk of explosion if the battery is replaced with an incorrect battery type. Dispose of the used battery in accordance with the manufacturer's instructions.
- Do not allow the phone, battery or accessories to come into contact with liquids or moisture at any time. Do not immerse in liquid.
- Do not paint the phone.
- Do not drop, throw or subject the phone to rough treatment.
- Do not place the phone alongside computer disks, credit cards, travel cards and other magnetic media. The information contained on disks or cards may be affected by the phone.
- Do not leave the phone or the battery in places where the temperature could exceed 60 °C, e.g. on a car dashboard or a window sill, behind glass in direct sunlight, etc.
- Do not remove the battery while the phone is switched on.
- Take care not to allow metal objects, such as coins or key rings to contact or short-circuit the battery terminals.

- Do not dispose of batteries in a fire. Dispose of Li-ION batteries at a Li-ION recycling point. For more specific battery and power supply information, see pages 7 and 8.
- Do not put the battery in your mouth, as battery electrolytes may be toxic if swallowed.
- Do not attempt to dismantle the phone or any of its accessories.
- Do not put a battery into a microwave oven, dryer or high-pressure container.
- Do not let the battery come into direct contact with an electric outlet or cigarette lighter charger. Use only authorised charger units.
- Do not pierce the battery with a sharp object such as a needle.
- When the battery is thrown away, be sure it is non-conducting by applying vinyl tape to the (+) and (-) terminals.
- Do not disassemble or modify the battery.
- Do not solder the battery directly.
- Stop using the battery if you detect any abnormalities, such as odour, discolouration or heat during use, charge or storage.
- Do not use the phone with a damaged or misshapen battery.
- In the unlikely event of a battery leak, take care to keep the battery discharge away from your eyes or skin. If the leakage does come into contact with the eyes or skin, please flush thoroughly in clean water and consult a doctor.
- Remove a worn out battery immediately.
- The earpiece may become warm during normal use. Also, the phone itself may become warm while the battery is being charged.
- When a phone is set to Vibration mode, the vibration can sometimes cause your phone to move. Be careful not to place the phone near heat sources (such as a heater) or too close to the edge of the table.
- Use an anti-static cloth to clean the phone. Do not use an ordinary dry cloth or electrostatically charged cloth. Do not use chemical or abrasive cleaners as these could damage the case.
- Remember to recycle the cardboard packaging supplied with this phone.
- Remember to make backup copies of all important data on your phone.
- Do not leave the battery pack empty or disconnected for a long time, otherwise some data may be initialised.
- Take care not to put your phone in your back pocket and then sit on it. Also, do not put your phone at the bottom of a bag where it may subject to excessive weight or pressure. Doing so may damage the LCD and camera lens and cause them to malfunction.
- Hold the phone away from your ear when you
 - Play video/music on the Multimedia Player
 - Play the ringtone through the speaker.
 It may damage, or irritate your ears.

Safety

The use of mobile phones is not allowed in some radiation-sensitive areas, such as hospitals, research centres and aircraft. Ensure that you switch off your phone in these areas. If in doubt, remove the battery.

Aircraft safety

- Switch off your phone and remove its battery when inside or near an aircraft. The use of phones in aircraft is illegal. It may be dangerous to the operation of the aircraft and it may disrupt the mobile network. Failure to observe this instruction may lead to suspension or denial of mobile network services to the offender or legal action or both.
- Do not use the phone on the ground without the permission of the ground staff.

Hospital safety

- Switch off your phone and remove its battery in areas where the use of phones is prohibited. Follow the instructions given by the respective medical centre regarding the use of mobile phones on their premises.

General safety

- Observe "Turn off mobile" signs, such as those near petrol stations, chemicals or explosives and switch off your phone.
- If you have a heart condition, be careful with the call vibration or tone volume settings.
- Do not allow children to play with the phone, charger or batteries.
- Do not use the phone where blasting is in progress.
- The operation of some medical electronic devices, such as hearing aids and pacemakers, may be affected if you use a mobile phone next to them. Observe any warning signs and the manufacturer's recommendations.
- Your phone contains metal which may cause a skin irritation, a rash or eczema.

Road safety

- You **MUST** exercise proper control of your vehicle at all times. Give your full attention to driving.
- Observe all local safety regulations regarding the use of mobile phones while driving.
- Pull off the road and park before making or answering a call.
- You **MUST NOT** stop on the hard shoulder of a motorway to answer or make a call, except in an emergency.
- Switch off your phone at a refuelling point, such as a petrol station, even if you are not refuelling your own car.
- Do not store or carry flammable or explosive materials in the same compartment as a radio transmitter.
- Electronic vehicle systems, such as anti-lock brakes, speed control and fuel injection systems are not normally affected by radio transmissions. The manufacturer of such equipment can advise if it is adequately shielded from radio transmissions. If you suspect vehicle problems caused by radio transmissions, consult your dealer and do not switch on the phone until it has been checked by qualified approved installers.

- Check if local laws and/or regulations restrict the use of phones while driving.

Vehicles equipped with an airbag

An airbag inflates with great force. Do not place objects, including either installed or portable wireless equipment, in the area over the airbag or in the airbag deployment area. If in-vehicle wireless equipment is improperly installed and the airbag inflates, serious injury could result.

Third party equipment

The use of third party equipment, batteries, cables or accessories, not made or authorised by NEC, may invalidate the warranty of your phone and also adversely affect the phone's operation.

Service

The phone, battery and charger contain no user-serviceable parts. We recommend that your NEC phone is serviced or repaired by an NEC authorised service centre. Please contact **3** or NEC for advice.

Efficient use

The phone has an internal antenna. For optimum performance with minimum power consumption, please do not cover the internal antenna area with your hand. Covering the internal antenna affects call quality, may cause the phone to operate at higher power levels than needed and may shorten talk and standby times.

Radio frequency energy

Your phone is a low-power radio transmitter/receiver. When it is turned on, it intermittently receives and transmits radio frequency (RF) energy (radio waves). The system that handles the call controls the power level at which the phone transmits.

Exposure to radio frequency energy

The phone is designed not to exceed the limits for exposure to RF energy set by national authorities and international health agencies.* These limits are part of comprehensive guidelines and establish permitted levels of radio wave exposure for the general population. The guidelines were developed by independent scientific organisations such as ICNIRP (International Commission on Non-ionizing Radiation Protection) through periodic and thorough evaluation of scientific studies. The limits include a substantial safety margin designed to assure the safety of all persons, regardless of age and health and to account for any variations in measurements.

*Examples of radio frequency exposure guidelines and standards that the phone is designed to conform to:

- ICNIRP, Guidelines for limiting exposure to time-varying electric, magnetic and electromagnetic fields (up to 300 GHz)- International Commission on Non-Ionizing Radiation Protection (ICNIRP). Health Physics, vol.74. pp, 494-522, April 1998.
- 99/519/EC, EU Council Recommendation on the limitation of exposure of the general public to electromagnetic fields 0 Hz-300 GHz. Official Journal of the European Communities, July 12, 1999.
- ANSI/IEEE C95.1-1992. "Safety levels with respect to human exposure to radio frequency electromagnetic fields, 3kHz to 300 GHz". The Institute of Electrical and Electronics Engineers Inc., New York, 1991.

- FCC Report and Order, ET Docket 93-62, FCC 96-326, Federal Communications Commission (FCC), August 1996.
- Radiocommunications (Electromagnetic Radiation Human Exposure) Standard 1999, Australian Communications Authority (ACA), May 1999.

Declaration of conformity

We declare under our sole responsibility that the product(s) detailed in this manual, and in combination with our accessories, conform to the essential requirements of European Union Directive 1999/5/EC Radio and Telecommunications Terminal Equipment Directive requirements 3.1(a), 3.1(b), 3.2.

Con la presente NEC dichiara, sotto la propria responsabilità, che il prodotto descritto in questo manuale (e in combinazione con i propri accessori), è conforme ai requisiti essenziali e alle disposizioni pertinenti stabilite dalla direttiva radio 1999/5/CE e ai requisiti 3.1(a), 3.1(b), 3.2 stabiliti dalle direttive per i terminali di telecomunicazioni.

Nous déclarons sous notre unique responsabilité que le(s) produit(s) présentés dans ce manuel et leurs accessoires sont conformes aux conditions de la Directive de l'Union Européenne 1999/5/EC sur les équipements de terminaison radioélectriques et de télécommunications, 3.1(a), 3.1(b), 3.2.

Wir erklären in alleiniger Verantwortung, dass die in diesem Handbuch aufgeführten Produkte allein und in Verbindung mit den von uns hergestellten Zubehörzeugnissen den grundlegenden Vorschriften und Bestimmungen der EG-Richtlinie 1999/5/EC, Funkund Telekommunikationsendgeräte, Abschnitte 3.1(a), 3.1(b) und 3.2 entsprechen.

Vi tar ansvar för att produkten/produkterna som beskrivs i manualen, också i kombination med våra tillbehör, överensstämmer med de väsentliga krav som beskrivs i 3.1(a), 3.1(b), 3.2 i Rådets direktiv om radioutrustning och teleterminalutrustning (1999/5/EG).

A copy of the "Declaration of Conformity" certificate can be found on www.nec europe.com.

Memory card

- Use only "Memory Stick Duo" (up to 128MB) in the e228.
- Always insert/remove the memory card while the phone power is off. If you remove the memory card while an application is writing into it, it may be damaged.
- Make sure you insert the memory card in the right direction, otherwise the phone may be damaged.
- To check whether a memory card is damaged, use the check disc function. For information on how to check the memory card, refer to **Check mem. card** on page 89.
- If you cannot fix the damage using the check disk function, format the memory card.
- The memory card cannot be used for recording copyright-protected data.
- Even if this memory card is used with "Memory Stick PRO™" compliant products, the data read/write speed of this medium will not change.
- Always insert the memory card with the memory erasure prevention switch unlocked.

- When you set the memory card erasure prevention switch to "LOCK", data cannot be recorded, edited or erased. Use this lock function when using the card with other devices, such as a PC.
- Use a sharp object, such as a ballpoint pen, to move the erasure prevention switch.
- Data may be damaged if:
 - you remove the memory card or turn off the phone while it is reading or writing data.
 - you use the memory card in a location subject to the effects of static electricity or electric noise.
- We recommend that you make a backup copy of important data that you record on the memory card. To make a backup, copy the data to a PC hard disk, etc.
- Do not write forcefully on the memo area.
- Carry and store the memory card in its case.
- To avoid damage or contamination, do not touch the memory card's connector
- Prevent dust, dirt and/or foreign objects from getting into the adapter.
- Do not strike, bend or drop the memory card.
- Do not disassemble or modify the memory card.
- Do not allow the memory card to get wet.
- Do not store the memory card in a location that is:
 - extremely hot, such as in a car parked in the sun.
 - under direct sunlight.
 - very humid or subject to corrosive substances.
- Data read/write speed may vary depending on the combination of the memory card and "Memory Stick Duo" compliant product you use.
- Do not insert the memory card directly into standard "Memory Stick" compliant products.
- Insert the memory card fully into the adapter until it clicks into place. Otherwise, it will not operate correctly.

Copyright Notice

The video/audio recordings you make/download are protected by copyright laws. They are for personal use only and must not be otherwise used without the permission of the copyright owner.

Contents

Important Safety Information	PL-1
Contents	CL-1
Introducing your e228	1
Overview of the e228	1
Setting up your e228	5
USIM Card	5
To Insert/Remove the USIM Card	5
Battery	7
To Insert the Battery	7
To Charge the Battery Using the Charger	7
Inserting the Memory card	9
Switching your e228 on and off	11
To Switch On	11
To Switch Off	11
Power Saver	12
Setting the Clock	12
To Set the Clock	12
Entering your PIN Code	12
To Enter your PIN Code	12
Check your own number	12
Understanding the Menus	13
Menu options	14
To set an image as wallpaper	14
Quick Menu and Home Screen Shortcut	15
Taskbar	17
Taskbar	17
Making and Receiving Calls	18
Making a Voice Call	18

To Make a Voice Call	18
Call Logs	20
Receiving a Voice Call	21
To Receive a Call	21
Voicemail	22
During a Voice Call	23
To Make a Second Call	23
To Receive a Second Call	23
To Switch to a Grouptalk	24
Other Operations During a Call	24
Making and Receiving a Video Call	25
To Make a Video Call to a Video Capable phone	25
To Make a Video Call to a PC with Webcam	26
To Receive a Video Call	26
Operations During a Video Call	27
Locking your e228	28
Setting the Key lock	28
To set the Key lock on/off	28
Emergency calls under the Key lock	28
Setting up your Contacts	29
Contact Entries	29
To Register a New Entry in the Contact List	30
To Add a New Contact Group	30
Entering Text	32
Text entry	33
Multitap Text (ABC) Input	34
T9® Text Input	34
Numeric Input	35
Symbol Input	35
Other things you can do when editing text	36
To Enter a Space	36

To Insert a New Line	36
To Change the Case	36
To Change to Delete/Backspace Mode	36
To Change to Insert/Overwrite Mode	36
To Copy/Cut and Paste the Text	36
Using Messaging	37
Overview	37
Message Menus	39
Writing and Sending a New Message	43
New Text Message	43
New Video Message	44
New Multimedia Message	45
New Email	45
To Edit a Slide Show	48
Receiving and Reading a Message	49
To Receive a Video Message or Multimedia Message	49
To Receive a Video Message/Multimedia Message Manually	49
To Read a Message	50
To Control the Multimedia Message Player	55
Replying and Forwarding	55
To Reply to a Received Message in Inbox	55
To Forward a Received Message in Inbox	55
To Reply to a Received Message	56
Organising Messages	57
Creating Folders	57
Remote mailbox	57
Copying or Moving Messages	57
To Copy/Move Messages to the Memory Card	57
To Create a Folder Under My Folders	58
Changing the Settings on your e228	59
Handset Settings	60

Handset profile	61
Call time info.	62
Call options	62
Making calls	63
Video calls	64
Camera settings	65
Video call options	65
Screen settings	66
Network setup	67
Security	68
Locks	68
Set codes	68
Supplementary	69
Date and time	70
Language	71
Clear settings	71
Using the Browser to Access the Internet	72
Browser Menus	72
To End a Browser session	76
To Download and Save a File in your e228 File Manager	76
To Bookmark	76
Using your e228's Advanced Features	78
Photo/Video Camera	78
To Take and Send a Photo/Video in a Message	78
Multiple selections	79
To Select Multiple Items	79
Multi-call/Multi-task	79
To Start/Switch Tasks During Multitasking	80
High-Speed Data Communications	80
Messaging	81
Video Call (available in 3G coverage only)	82

Using the File Manager	83
Handset memory	83
Memory card	85
What is Memory Stick Duo™?	87
Operations	88
Memory card tool	89
Running Java™ Applications	90
Applications	90
To Run Downloaded Applications	90
Set permissions	91
Settings	91
Using the Multimedia Centre	93
Capture	94
Camera Capture	94
Camera Options menu	97
Camera Settings	98
To Take a Photo	98
To Make a Video	99
To Record Sound	100
Player	101
To View an Image File	102
To Play a Video File	103
To Play an Audio File	105
Connecting your e228 to a PC	107
USB	107
To Establish a Dial-up Connection to a PC using a USB Cable	108
Data exchange	108
To activate Data Exchange	109
To Transfer Data between the phone and a PC	109
Synchronisation	109
To perform local USB synchronisation	109

To perform OTA remote synchronisation	109
Synchronisation Options	110
To Register a Server	110
Synchronisation Settings	111
Using the Toolbox	113
Calendar	114
To add a new calendar entry	115
To edit a calendar entry	117
To synchronise calendar entries between e228 and a PC	117
To delete a calendar entry or entries	118
To Do	119
To Add a New To Do Task	119
To Edit To Do Tasks	121
To Delete To Do Tasks	121
Alarm clock	123
To Set an Alarm	123
To Edit an Alarm	125
To Change alarm clock status	125
To Delete Alarms	125
Notepad	126
To Create a New Notepad Entry	126
To Edit a Notepad Entry	126
To Delete a Notepad Entry	127
Calculator	128
Calculator	128
To Use the Calculator	128
Currency Calculation	129
To Convert one Currency to Another	129
Call memo	130
To Listen to a Call Memo	130
To Delete a Call Memo	130

Shortcut Keys	131
Index	137

Introducing your e228

Your e228 combines a wide range of features in a technologically advanced phone, capable of operating in UMTS (Universal Mobile Telecommunication System), also known as 3G, GSM (Global System for Mobile Communications) or 2G and GPRS (General Packet Radio Service) or 2.5G.

3G allows much greater data speeds than 2G/2.5G networks and enables you to make video calls, send multimedia messages, view photos and videos and much more.

Overview of the e228

Front and sides

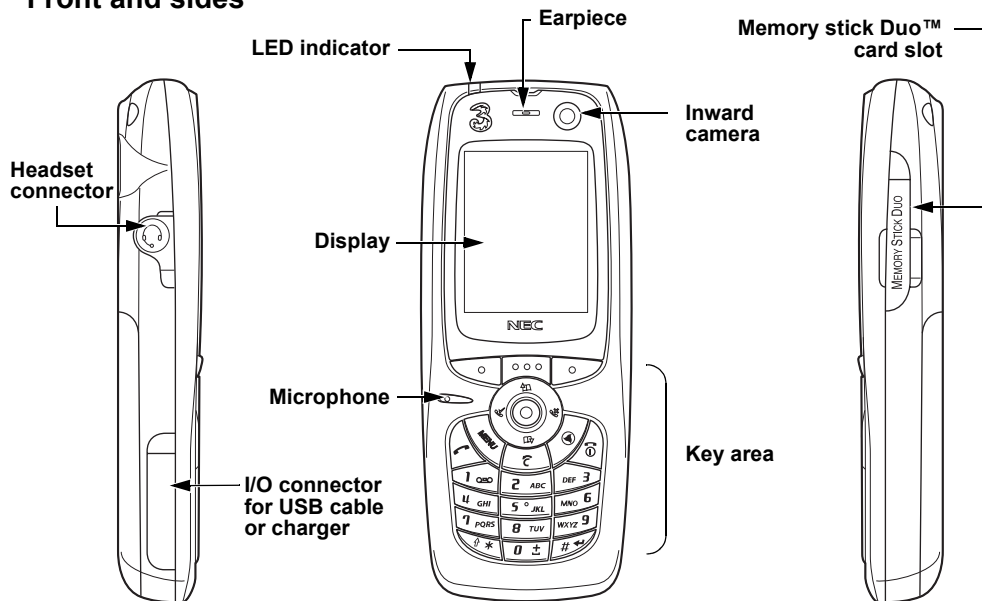

Rear

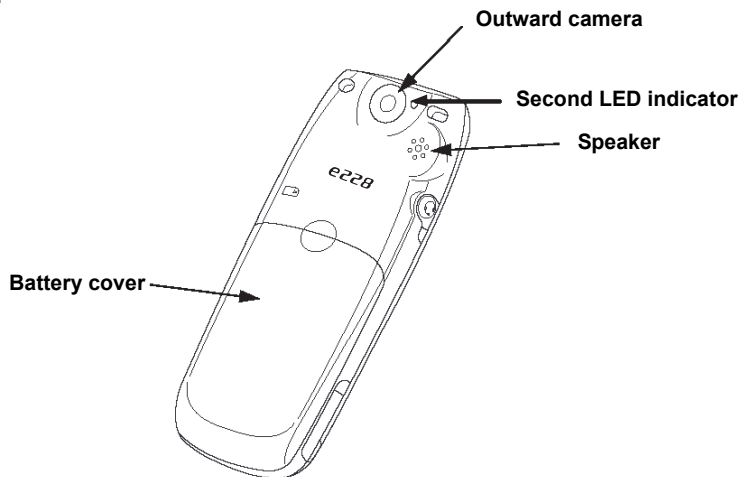

Keys

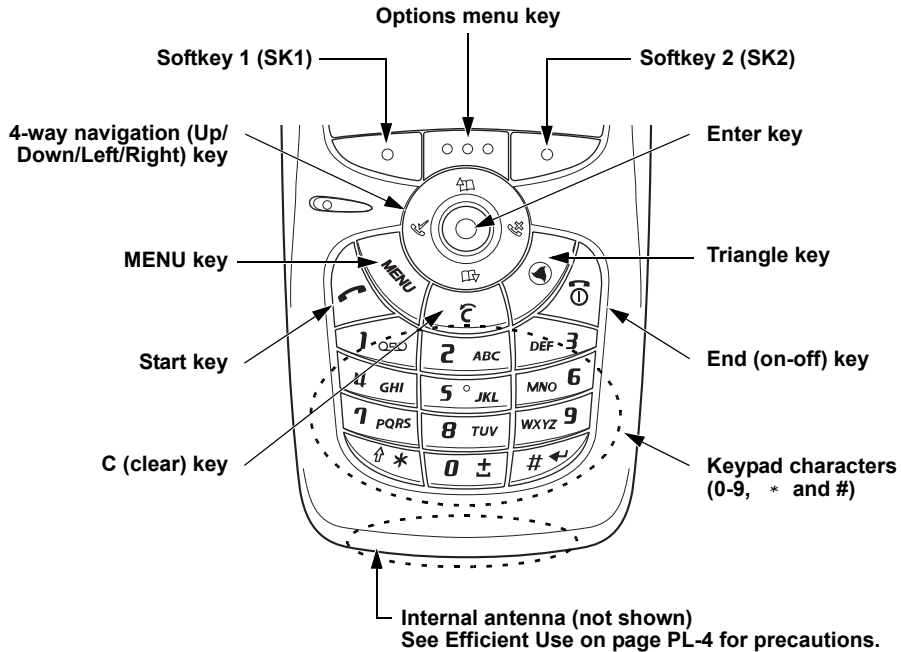

Home screen and Display symbols

Home screen

Status Indicators



Home screen shortcuts

Get quick access to specific functions with the Home screen shortcut icons. (See page 16.)

- Video call options
- Music files
- Calendar
- Missed call Indicator
- Video folder
- Play music
- My photos
- Ringtunes

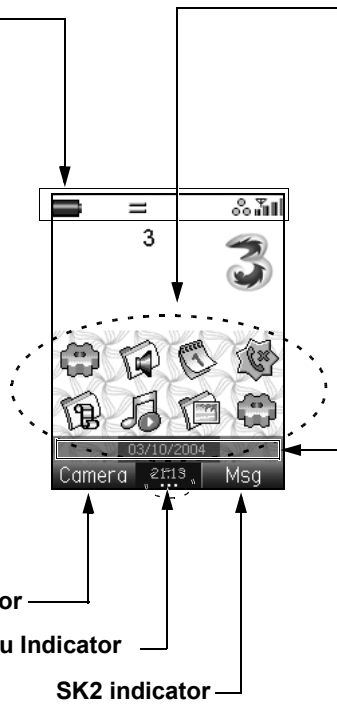

Mode Indicators

- Handset profile: Standard/Meeting/Outdoor/Car
- Headset
- Key lock
- Dial lock
- Backlight off
- Alarm set
- Vibration set
- Voice mail received
- Call forwarded

SK1 indicator
Options menu Indicator
SK2 indicator

Setting up your e228

This section explains how to prepare your phone for use.

Before you use your phone you must do the following:

- Insert a valid USIM (Universal Subscriber Identity Module) card
- Charge the battery
- Insert the memory card (Memory Stick Duo™) in the side slot (optional)
- Set the date and time

This section shows you what to do step by step.

USIM Card

3 provides you with a USIM card that must be inserted into your phone.

The USIM card holder is located underneath the battery. If the USIM card is removed, then the phone becomes unusable until a valid USIM is inserted.

 Always disconnect the charger and other accessories from your phone before inserting and removing your USIM card.

To Insert/Remove the USIM Card

Ensure that the power is off. If the power is on, press and hold the **End (On-Off)** key until power is off.

Insert/remove the USIM card as shown in the diagram on the next page.

Insert a USIM card

1 Remove the battery cover (and the battery).

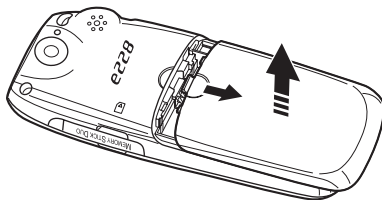

2 Insert the USIM card into the USIM card holder.

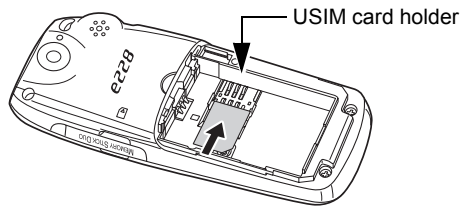

3 Slide the USIM card into place.

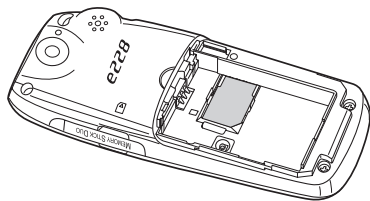

Battery

To Insert the Battery

- 1 If a battery is already in place, ensure your phone is switched off before you attempt to insert the new battery.
- 2 Open the battery cover. (see the diagram on page 6).
- 3 Ensure that the battery's label is facing upwards when fitting the battery. Place the top of the battery into position and then push the lower section of the battery into place.
- 4 Close the battery cover.

You can charge the battery whenever you wish without affecting the performance of the phone.



Your e228 automatically switches off if the battery voltage is too low.



Batteries have a life cycle. If you find that the amount of times you have to charge the battery is increasing dramatically, the battery life may be coming to an end. Use only the NEC original or approved batteries. Unapproved batteries can impair the performance of the phone and invalidate the warranty.



When the battery is not being used for a long period of time, remove it from your e228 and store in a cool, dry place.



A battery that has not been used for a long period of time needs to be completely discharged and then recharged two or three times before reaching full capacity.





Charging

To Charge the Battery Using the Charger

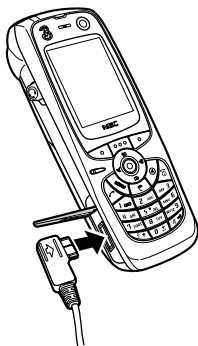
- 1 Insert the battery into the phone (see **To Insert the Battery section above**).
- 2 Connect the charger plug to your e228 I/O connector (see the diagram on the next page).
- 3 Plug the charger into a mains socket. The LED indicator on your e228 lights up while charging is in progress and goes off when charging is completed.
- 4 After charging is completed, unplug the charger from the I/O connector.

Connecting the battery charger to the phone



-  When the phone is being used, the battery level may decrease even if the phone remains connected to the charger.
-  The battery must be charged at room temperature. Ensure that your phone is switched off. If the phone temperature is high, wait until it returns to a normal temperature.
-  The recommended battery charge time is approximately two hours.
-  Stop charging the battery if charging is not completed within five hours. Remove the charger from the phone and connect it again to restart the charging.
-  The LED indicator may take a few minutes to light up after the phone starts charging an empty battery.

Low Battery Alarm

The battery power has 4 levels and is indicated by the following icons:



When the battery runs out, the following image blinks and a warning alarm may be heard. The phone switches off shortly afterwards.

Low battery alarm



During a call, the image above and an audio alarm indicate low-power. After approximately 60 seconds the call is disconnected.

The volume level of the low-power warning alarm depends on the ringtone volume level on standby and the earpiece volume during a call.

Inserting the Memory card

Your e228 supports a "Memory Stick Duo™" (referred to as the memory card) up to 128MB. Please read the important instructions about the memory card in the **Important Safety Information** section on page PL-5 and in the **File Manager** section on page 83.



Always insert/remove the memory card with the phone switched off.



The Memory Stick Duo™ is available as an accessory from a variety of electrical retail outlets.

The following shows the memory card and its components.

Memory Card (Memory Stick Duo™) Overview

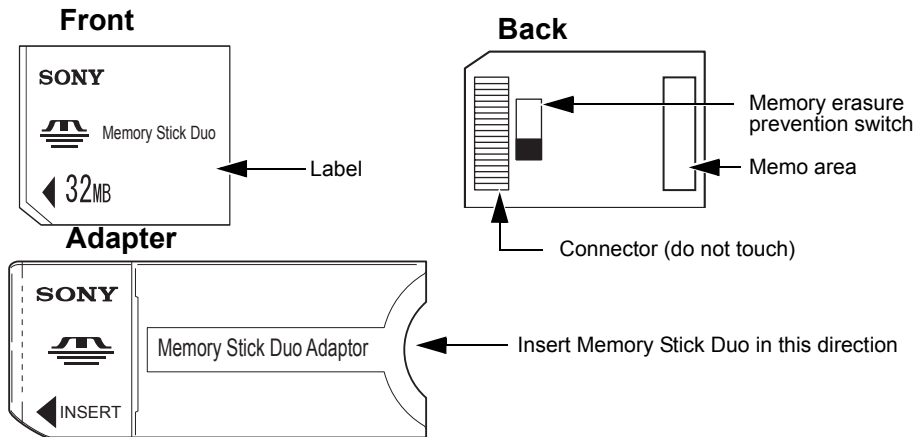

To insert the memory card

Note Always insert/remove the memory card with the phone switched off.

Insert the memory card into the slot with the back facing you, until the memory card is fully inserted into the slot, as shown in the figure below.

Setting/removing the memory card

Open the Memory Stick Duo™ card slot.



Insert the memory card.



Remove the memory card.



To remove the memory card

- 1 Push the memory card to release.
- 2 Carefully pull the memory card out of the slot.

Switching your e228 on and off

To Switch On

After inserting the USIM card (see pages 5 and 6) and the battery (see pages 7 and 8), press the **End (On-Off)** key until the phone switches on (approximately two seconds).

To Switch Off

In Standby mode, press and hold the End (On-Off) key until the phone powers down. There may be some delay while the phone switches off. Do not attempt to switch the phone on again during this time.

Power Saver

The power saver function turns the screen off when the phone is left idle for a certain period of time. You can turn the screen back on by pressing any key.

Setting the Clock

When using your e228 for the first time you are prompted to set the current date and time.

To Set the Clock

- 1 Press the **MENU** key, select the **Settings** icon, select **Date and time**, **Set date and time** and **Home time**.
- 2 Enter the current date and time. Refer to **Date and time** on page 70 for details.

Entering your PIN Code

If you want to secure information in your phone, you can activate your PIN code so that the phone cannot be used without entering the PIN as you switch on your phone. (For information about how to activate PIN codes, refer to **Security** on page 68 in the **Settings** section.)

 PIN1 and PIN2 numbers are usually supplied with your USIM card. If not, or you have lost them, contact **3**.

To Enter your PIN Code

- 1 Ensure that your USIM card is in your e228 and that the battery is charged.
- 2 Press and hold the **End (On-Off)** key until power is on.
- 3 If the **Password** screen is displayed, enter your PIN1. The code you enter appears as asterisks (*).

 If you make a mistake while entering your PIN, delete the wrong number by pressing the **C** key.

- 4 Press the **SK1 (OK)**.
When connecting to the network, the name **3** appears. If you are connecting onto another network, the name of another operator appears.

Check your own number

To check your own number, press the **Menu** key and press **0** from the Home screen.

Understanding the Menu

This section describes how to use the menus.

You can do various tasks on your e228 using the various menus and submenus. By selecting icons, menus, submenus, options menus or building your own shortcuts, you can access the numerous functions and their settings.

- Icon list

An icon is a graphic image with a name that represents and links to a category of functions or a particular function.

- Menu list

Your e228's functions are reached through a system of menus. You can select a menu option by scrolling up or down to select an item followed by the **Enter** key. Alternatively, press the item's corresponding number. If there are more than nine items in a menu, not all of the choices are visible on the same screen. You can scroll up or down to view the next screen. You can reach the main menu by pressing the **MENU** key.

- Options menu list (Press the **Options menu** key when available.)

This is a dynamic menu. That is, the options available depend on the function you are using. While an Options menu is available, the **Options menu** indicator is on (three white dots appear below the time display at the bottom, centre of the screen). Press the **Options menu** key to access the menu. Refer to **Display** on page 4 for details.

Main Menu



To Display the Main Menu:
Press the **MENU** key.

To highlight a Menu icon:
Press the **4-way navigation** key or the icon ID number.

← Icon ID number

Menu options

This section shows you how to use the menus.

The following example shows you how to set your wallpaper.

To set an image as wallpaper

To	Do This
1 Display Main Menu	Press the MENU key. Main Menu is displayed.
2 Highlight Settings icon	Press the 4-way navigation key to highlight the Settings icon. Whenever an icon is highlighted it has a box around it and the icon name appears at the bottom of the display.
3 Select Settings icon	Press the Enter key. The User settings menu is displayed.
4 Select Screen settings	<ul style="list-style-type: none">• Press the Up and Down keys to highlight Screen settings and press the Enter key, or, alternatively press 3.
5 Select Wallpaper	<ul style="list-style-type: none">• Press the Up and Down keys to highlight Wallpaper and press the Enter key, or, alternatively press 2.
6 Select an image	Press the Enter key and open the folders. Highlight an image file and press the Enter key. The selected image is displayed in the box.
7 Set the selected image as wallpaper	Press SK1 (OK) . The image is set as wallpaper and the screen returns to the Screen settings list menu.

Quick Menu and Home Screen Shortcut

You can create shortcuts to an application or a function that you frequently use in the **Quick menu** or on the Home screen. Whenever you can create a shortcut to an application/function, the **Link this** menu is available on the **SK1**. From the **SK1**, you can select where to add the shortcut, in the **Quick menu** list or on the Home screen.

- **Quick menu**

The Quick menu is your customised list of shortcuts to applications/functions. Pressing the **MENU** key twice on the Home screen or pressing the **SK2 (Quick)** on **Main Menu** displays the **Quick menu**. Highlight the required shortcut by pressing the **Up** and **Down** keys and then press **Enter** key to activate the application/function.



The Quick menu display varies depending on the region.

- **Home screen shortcut**

You can also create shortcut icons to applications/functions on the Home screen. Pressing the Enter key followed by the **4-way navigation** keys on the Home screen highlights the shortcuts. Press the **Enter** key to select the highlighted shortcut to activate the application/function.

Quick menu



What you can do from the Home Screen

Apart from creating shortcuts, you can activate various functions and settings and customise your Home screen. You can press the **C** key several times to return to the Home screen. To focus on a home screen shortcut, press the **Enter** key. You can do the following from the Home screen.

Task	Steps
Activating a Home screen shortcut	Press the Enter key on the Home screen. Use the navigation keys to select the desired shortcut and press the Enter key to select.
Changing the active phone profile	Press the Options menu key and select Handset profile . Select a profile option.
Accessing the Quick menu	Press the Options menu key and select Quick menu .
Displaying call logs	Press the Options menu key and select Call logs .
Setting the dial lock function	Press the Options menu key and select and Dial lock . Refer to Dial lock on page 68.
Deleting a Home screen shortcut	Select the Home screen shortcut, press the SK2 (Delete) .
Moving a Home screen shortcut	Select the Home screen shortcut, press the SK1 (Move) . Highlight the new place and press the SK1 (Place) .
Pasting the copied phone number onto the Home screen (dialler is activated)	After you copy a phone number, return to the Home screen and press the Options menu key and select Paste . The copied phone number is pasted on the dialler.
Saving the input/copied phone number in Contact list	After you input/copy a phone number on the Home screen, press the SK2 (Add) .
Sending a text message to the input/copied phone number	After you enter/copy a phone number, press the Options menu key and select Send message .
Setting the Home screen type	Press the Options menu key and select Home screen type . Select Standard or Show calendar (the monthly view calendar).
Turning the key lock on/off	Press the MENU key and the * key.

Taskbar

Pressing and holding the **MENU** key displays the taskbar at the bottom of the screen. When there are multiple tasks active at the same time, they are displayed on the taskbar as icons. Highlight using the **Left** and **Right** keys and press the **Enter** key to switch to that task.

On the taskbar, you can end the selected task by pressing the **End** key or the **SK1 (End task)**. Pressing the **SK2 (End all)** ends all tasks. You can cancel the taskbar display by pressing the **C** key.

 When you end tasks by pressing the **End key**, **SK1 (End task)** or **SK2 (End all)** the tasks are interrupted, and any unsaved changes discarded.

Taskbar



← Active tasks (Home screen/Messages/Browser)

↑ Press the SK1 (End task) to end the selected task.

↑ Press the SK2 (End all) to end all the active tasks.

Making and Receiving Calls

This section describes how to make and receive calls.

This section guides you through the following step by step:

- Making a Voice Call
- Receiving a Voice Call
- Other things that you can do during a Voice Call
- Making and Receiving a Video Call (available in 3G coverage only)

 When using the headset, you can start/end a voice call using the switch on the microphone.

Making a Voice Call

To Make a Voice Call

To	Do This
1 Enter the phone number	Enter the phone number using the keypad. Note: To correct mistakes, press the C key briefly to delete the last number or press and hold the C key to clear all the numbers.
2 Dial the phone number	Press the Start key.
3 Talk	
4 End the call	Press the End key.

Useful Tips

Task	Steps
Making an emergency call	Enter the emergency number 999 (UK only), 000 (Australia only) or 112 . Press the Start key to make an emergency call. Note: When the Key lock is set, follow the instructions on page 28 to make an emergency call. Tell the operator your location and which emergency service you require: ambulance, police, rescue services, etc. If possible, remain where you are and keep the line connected.

Task	Steps
Making an international call	<p>Press and hold 0 to display a "+" symbol.</p> <p>Enter the international country code, then the phone number.</p> <p>Press the Start key to make an international call.</p>
Making a call using the Contact list	<p>Press the MENU key and select Contacts or press the Up or Down key.</p> <p>Note: To scroll the contact list in alphabetical order, press the Down key.</p> <p>Note: From the keypad, enter the first letter of contact entry you want to select. For example, press the 2 key twice to display the Contact entry list starting with B.</p> <p>Search and select the addressee's phone number.</p> <p>Press the Start key to make a call using the contact list.</p>
Making a call from Incoming calls list	<p>From the Home screen, press the Left key. Alternatively press the Options menu key, Call logs then Incoming calls.</p> <p>Select the phone number on the list.</p> <p>Press the Start key to make a call from the Incoming calls list.</p>
Making a call from Outgoing calls list	<p>From the Home screen, press the Start key. Alternatively press the Options menu key, Call logs then Outgoing calls.</p> <p>Select the phone number on the list.</p> <p>Press the Start key to make a call from the Outgoing calls list.</p>
Making a call from Missed calls list	<p>From the Home screen, press the Right key. Alternatively press the Options menu key, Call logs then Missed calls.</p> <p>Select the phone number on the list.</p> <p>Press the Start key to make a call from the Missed calls list.</p>
Speed dial	<p>Enter a contact memory number from 2 to 99. Press the Start key to call the phone number registered for the memory number.</p> <p>For the contact memory whose number is 2 to 9, you can also make a call by pressing and holding the key assigned to the number you want to dial.</p> <p>The memory number from 2 to 9 can be changed from the Speed dial screen. To find the Speed dial screen, press the MENU key, select Contacts, press the Options menu key and select Speed dial.</p> <p>Note: Pressing 1 and the Start key, or pressing and holding 1 calls the voicemail centre.</p> <p>Note: If more than one phone number is registered for a memory number, the first number is used to make a call.</p>

Task	Steps
Pause Dial	Enter the phone number, then press and hold # to insert a pause (displayed as p). Input the numbers to call, inserting pauses where necessary. Press the Start to dial the input numbers. When the other party answers the call, press the SK1 (Send) to dial the numbers after the pause. Keep pressing the SK1 until you have dialled all the required numbers.
Entering the sub-address of a phone number	After entering the phone number, press the * key and enter the sub-address number. You can specify one sub-address (office extension number, etc.) for each.

Call Logs

Press the **Options** menu key → **Call logs**

Call logs are lists of call records such as incoming/outgoing/missed calls. Up to 20 entries are saved in each call log. You can make a call using these logs, and do the following from Call logs on the Options menu.

Item	Description
Outgoing calls	You can also see the Outgoing calls by pressing Start key from the Home screen.
Incoming calls	You can also see the Incoming calls by pressing Left key from the Home screen.
Missed calls	You can also see the Missed calls by pressing Right key from the Home screen.
Clear all logs	Deletes all the call log data.
Automatic delete	Turns the automatic deletion function on/off. This function automatically deletes the call logs when you switch off the phone.
Duplicate records	Selects whether to allow multiple records to/from the same number to be made on the log or not. Select Allow or Do not allow .



If you miss a call, it is shown as a missed call by an icon on the Home screen. After you display **Missed calls** the icon disappears.

Receiving a Voice Call

When someone makes a voice call to your **3** number, the ringtone, the illumination and the vibrate function are activated depending on your settings. When the Calling Line Identification (CLI) function has been activated by the caller, the caller's phone number is displayed. If the caller opts to hide their phone number, the e228 generates a message indicating that the phone number has been withheld.

Common Tasks

To Receive a Call

To	Do This
1 Answer the call	Press the Start key or SK1 (Answer) . Note: When Any key answer function is activated, you can press any key except the SK2 (Ignore) , End key,  and the Options menu key to answer the call. Refer to Call options on page 62 for details. Note: When the headset is connected, pressing the headset switch also answers the call.
2 Talk	
3 End the call	Press the End key. The call is disconnected and the call time duration is displayed.

Useful Tips

Useful tips for receiving a call are shown below:

Task	Steps
Turning off the ringtone	You can mute the ringtone by setting the active phone profile's Ring volume to Silent . Refer to Handset profile on page 61.
Turning off the ringtone while ringing	To mute the ringtone while ringing, press the C key.
Rejecting a call	While receiving a call, press the End key or the SK2 (Ignore) . Note: Rejected calls are diverted to the number registered in Call forwarding, If busy . This usually defaults to voicemail, depending on the network operator.
When you miss a call	If you miss a call, it is shown as a missed call by an icon on the Home screen. The missed call is saved to the Missed calls list. When you display Missed calls , the icon disappears.

Task	Steps
Rejecting the second call	<p>Press the Options menu key, Ignore call.</p> <p>Note: Rejected calls are diverted to the number registered in Call forwarding, if busy. This usually defaults to voicemail, depending on the network operator.</p>
Forwarding a voice call (available in 3G coverage only)	<p>Press the Options menu key, Divert call.</p> <p>The registered call forwarding number is displayed.</p> <p>Check the phone number and press the SK1 (OK).</p> <p>The call is diverted to the phone number registered in Call forwarding setting. (Refer to Call forwarding on page 69 for details.)</p> <p>If you want to divert a call to another number or there is no phone number registered, enter or search for the phone number.</p>

Voicemail

When you forward a call to the voicemail centre, the caller may leave a message for you. If a message is left, either a voicemail icon or message envelope is displayed on your screen. Call the voicemail centre to retrieve the message, following the instructions below. For how to set the voicemail setting, refer to **Voicemail** in **Call options** on page 63.

To	Do This
Call voicemail centre	<p>Do one of the following:</p> <ul style="list-style-type: none"> • Press and hold the 1 key, or • Press the 1 key and the Start key.

During a Voice Call



Some of the tasks described here are only available if you have subscribed to certain services. Ask **3** about details on service subscription.

Common Tasks

To Make a Second Call

To	Do This
1 Enter the second phone number	
2 Dial the second phone number	Press the Start key. The numbers you entered are dialed and the first call is automatically put on hold.
3 Talk	To switch calls: Press the SK1 (Swap) or press the Options menu key, Swap calls .
4 End the calls	To end the current call: Press the End key or press the Options menu key, End call and End active call . To end the call on hold: Press the Options menu key, End call and End held call . To end both calls: Press the End key twice.

To Receive a Second Call

To	Do This
1 Another call received during a call Answer the second call, i.e. another call received during the first call.	Press the SK1 (Answer) . The first call is automatically put on hold.
2 Talk	To switch calls: Press the SK1 (Swap) . Alternatively, press the Options menu , Swap calls .
3 End the call	To end the current call: Press the End key. Alternatively, press the Options menu key, End call and End active call . To end the held call: Press the Options menu key, End call and End held call . To end both calls: Press the End key twice.

To Switch to a Grouptalk

To	Do This
1 Switch to Grouptalk	(When there are two calls on-line: the current call and a held call) Press the Options menu key, Join calls .
2 Talk	Note: Press the Options menu key, Grouptalk . Pressing the SK1 (Split) splits the selected caller from the Grouptalk and the SK2 (Drop) drops the selected caller from the Grouptalk.
3 End the call	Press the End key.

Other Operations During a Call

To	Do This
Use the Scratchpad	If you enter keypad characters during a call, these characters remain displayed on the screen after the call is finished.
Adjust the earpiece volume	Press the Up and Down key to adjust the volume while on a call.
Search the contact list	Press the SK2 (Contact) to display the Contact list.
Put a call on hold	While talking, press the SK1 (Hold) . Alternatively, press the Options menu key and select Hold call . The call will be put on hold. To retrieve the call, press the SK1 (Retrieve) . Alternatively, press the Options menu key, Retrieve call .
Swapping the connected and held call	When you have a connected call and a held call, press the SK1 (Swap) . Alternatively, press the Options menu key, Swap calls . The connected call is put on hold and vice versa.
Record a Call memo	Press the Options menu key and select Call memo to start recording the conversation. To stop the recording, press the Enter key. Both your voice and the other party's voice are recorded. (20 seconds max.) Five call memos can be recorded in the phone. A call memo is displayed with its date and time of recording. For further information about using call memos, refer to Call memo on page 130. Note: Always ask the other party's permission to record. Note: You cannot attach call memos to messages or copy them to the memory card.

To	Do This
Activate Settings	<p>Press the Options menu key and select Settings to see the following settings:</p> <p>Auto answer: Turns on/off automatic answering.</p> <p>Set answer key: Selects Use any key or Send key only as the call answering key.</p> <p>Auto redial: Turns on/off automatic redial.</p> <p>Send DTMF tones: Enables/disables the sending of Dual Tone Multi Frequency (DTMF) signals.</p> <p>Divert to: Sets the phone number to forward the call to.</p> <p>Mute: Turns on/off mute.</p>
Receive a third call	<p>You can only receive a third call if you end one of the current/held calls. Press the Options menu key and select the appropriate option to end the current/held call.</p>

Making and Receiving a Video Call

 Available in 3G coverage only

For further information on changing the default settings for a video call, refer to **Video calls** on page 64.

To Make a Video Call to a Video Capable phone

To	Do This
1 Enter a phone number	Enter the phone number, using the keypad or the call logs. For further information on Call Logs , refer to page 20.
2 Start the video call	Press the SK1 (Vid. call) .
3 Talk and focus the camera	<p>When the other party responds, hold the camera towards you and talk. Adjust the camera position if necessary.</p> <p>Note: Handsfree is set by default for video calls.</p>
4 End the call	Press the End key.

To Make a Video Call to a PC with Webcam



This service is network dependent. Please contact 3 for further details.

To	Do This
1 Select the email address you want to contact	Select the email address from the contact list, the Incoming calls/Missed calls list, etc.
2 Start the video call	Press the SK1 (Vid. call) . Note: The video call may take some time to connect. Please be patient. The connection time also depends on how quickly the other party answers the call.

To Receive a Video Call

To	Do This
1 Receive a video call	The phone indicates that you are receiving a video call.
2 Answer the call	Press the Start key or SK1 (Answer) to answer and send the captured image from the active camera to the other party. Note: To answer the video call without sending your image, press the SK2 (No video) . The alternative photo is sent to the other party.

Useful Tips

Task	Steps
Making a video call using the contact list	<ol style="list-style-type: none">1 Press the MENU key and select Contacts or press the Up or Down key.2 Search and select the addressee's phone number/email address.3 Press the SK1 (Vid. call) to dial the phone number/email address.
Making a video call from the Missed calls number list	<ol style="list-style-type: none">1 Press the Right key to display Missed calls.2 Search and select the addressee's phone number/email address.3 Press the SK1 (Vid. call) to dial the phone number/email address.
Making a video call from Incoming calls number list	<ol style="list-style-type: none">1 Press the Left key to display Incoming calls.2 Search and select the addressee's phone number/email address.3 Press the SK1 (Vid. call) to dial the phone number.
Rejecting the incoming video call	<ol style="list-style-type: none">1 Press the End key or press the Options menu key and select Ignore.

Task	Steps
Screen setting	1 The received image and the sent image can both be displayed on the screen. Press the Options menu key. Switch between Use photo instead to hide your image (sent image)

Operations During a Video Call

Task	Steps
Setting the handsfree mode	Press the Options menu key and select Handsfree . Select Handsfree on or Handsfree off . When the handsfree option is on, the microphone sensitivity increases, and the other party's voice can be heard from the speaker. Press the Right key to zoom in or the Left key to zoom out.
Zoom in/out	
Turning the microphone on/off (sending/not sending your voice to the other party)	To turn the microphone on/off, do one of the following: <ul style="list-style-type: none"> • Press (Mute/Unmute) to switch the microphone on and off. • Alternatively, press the Options menu, Other settings and Mute settings. Select Mute or Unmute.
Switching cameras (Available only while sending the camera image)	Press the SK2 (In/Out) to switch to the other camera.
Turning your camera on/off (sending/not sending your image to the other party)	Press the Options menu , then either Use live video or Use photo instead (whichever is displayed).
Changing the screen display mode	Press the Options menu then Screen mode . Select My side is smaller (to display your image on the smaller window), My side is larger (to display your image on the larger window), Other side only (to display only the other party's image) or My side only (to display only your image).
Changing the picture quality	Press the Options menu key, Picture quality . Select Standard , Better picture (image quality has the priority) or Faster movement (capturing movement has the priority).
Changing the camera mode	Press the Options menu key, Camera mode . Select Portrait mode , Landscape mode or Night-time mode .
Setting the lighting mode	Press the Options menu key and Lighting settings . Select Sunny , Cloudy , Automatic or Indoors .
Setting the call time duration information	Press the Options menu key, Other settings and Show call length . Select Show call length or Do not show .
Adjusting the speaker volume	Press the Up and Down keys.

Locking your e228

This section describes how to prevent your phone from being used except for answering voice/video calls. Sometimes when a task has already started, it continues even after you have locked your phone.

 When your phone is locked, you cannot switch it off. Remember to unlock it before switching it off.

Setting the Key lock

You can only set the key lock from the Home screen. Even when some tasks are open, you can return to the Home screen by pressing the **Start** key.

To set the Key lock on/off

To	Do This
1 Set the Key lock on/off	On the Home screen, press the MENU key and * key.

Emergency calls under the Key lock

While the phone is locked, you can make emergency calls only to the designated numbers. Follow the steps below to make emergency calls while the key lock is set.

To	Do This
1 Enter the designated emergency number	Enter the designated emergency number (see Making an emergency call on page 18 for the designated numbers). The confirmation message is displayed. Note: The screen below is displayed until you enter the designated emergency number correctly.

Unlock instruction



2 Call the number	Press SK1 (Yes) . Your e228 is unlocked temporarily and the emergency call is made.
-------------------	---

Setting up your Contacts

This section describes how to work with contacts.

Press the **"MENU"** key → select **"Contacts"** icon

Contact Entries

Up to 500 entries can be registered from the phone Contact list. Up to 254 entries can be read from the USIM contact list, depending on your USIM card (please ask **3** for details).

 The maximum number of contacts in the e228 is affected by the number of fields used in each contact entry.

The following shows the data that you can enter under a name in the Contact list:

Data	Phone Contact List	USIM Contact List
Name	(32 single-byte characters max.)	(This item can be registered, edited and deleted.)
Nickname	(32 single-byte characters max.)	-
Image	One image file	-
Contact group	Choose from 16 groups	-
Phone number	Up to four phone numbers (36 digits max. for each) Up to 37 digits can be entered per phone number when it includes the international code "+".	One phone number (This item can be registered, edited and deleted.)
Email	Up to 3 email addresses Note: Though an email address can contain up to 90 single-byte characters when you register the Contact entry, it is limited to 31 single-byte characters when you send video calls.	-
URL	One homepage address (256 single-byte characters max.)	-

Common Tasks

To Register a New Entry in the Contact List

To	Do this
1 Start the Contacts function	Press the MENU key and select Contacts . Alternatively, press the Up or Down key.
2 Start a new contact entry	Press the Options menu key and select Add contact .
3 Fill in the data	Fill in data on the displayed Add contact screen and press the SK1 (OK) . The data you entered is saved as a contact entry. Note: You can change the Add contact field so that only the name, number and category is requested. To do this, press the Options menu key, select Settings and Set add method . Choose between Quick add and Standard method .

To Add a New Contact Group

To	Do this
1 Access the Contact list	Press the MENU key and select Contacts . Press the Options menu key and select Contact groups .
2 Edit the contact group profile	Select a contact group entry and press SK1 (Edit) to fill in the profile data. You can edit the group name, set a group image and select ringtunes, illumination and vibration patterns for incoming voice calls, video calls or messages from a member of that group.
3 Save the changes	Press the SK1 (OK) .
4 Register contact entries to the group	Display a contact entry. Press the Options menu key and select Edit contact . Select the group name in the group box. The profile is applied to all registered members.

Useful Tips

Task	Steps
Quickly displaying Contact numbers 1 to 99	Enter the memory number and press the # key.
Sorting contact entries	Press the Options menu key, select Settings , Sort records . Select the sorting method. Note: Available only when you access Contacts from the Main Menu.
Editing a contact entry	Search and select the entry and then press the Enter key twice.
Deleting a contact entry	Search and select the entry and then press the Options menu key. Select Delete and Selected data . Note: Available only when you access Contacts from the Main Menu.
Writing a message from a contact entry	Search and select the entry then press the Enter key. Highlight the phone number or email address and press the SK2 (Msg) . When an email address is highlighted, you can also open the message screen by pressing the Start key.
Copying and moving	Search and select the entry and press the Options menu key and select Copy or Move . Select the destination and press the Enter key. Note: Available only when you access Contacts from the Main Menu.
Extracting contact entry information	Search and select the entry and press the SK1 (Use) . The selected data is extracted the last application (message writer, notepad, etc.).
Displaying the contact memory status	Press the Options menu key and select Memory status . The total number of contact entries allowed for the default memory, used memory and free entry numbers are displayed.

Entering Text

This section describes how to enter and edit text.

There are four types of text entry:

- Multitap Text (ABC) Input: Where you press each key as many times as needed to display the character you want.
- T9® Text Input: Where intuitive texting predicts the word you are trying to enter.
- Numeric Input: Where you enter numbers.
- Symbol Input: Where you enter symbols, Greek characters, or characters with accents.

 T9® Text Input is covered by the United Kingdom Pat. No. 2238414B, Euro. Pat. No. 0 842 463 (96927260.8) and other patents pending.

 The maximum number of characters allowed in an item or a field is defined as the number of single-byte characters that can be input. When entering double byte characters such as accents (è, î, ô, etc.) or triple byte characters such as the Euro symbol (€), the maximum number of characters varies accordingly.

Here are some examples of text entry methods.

Text entry

Text entry field

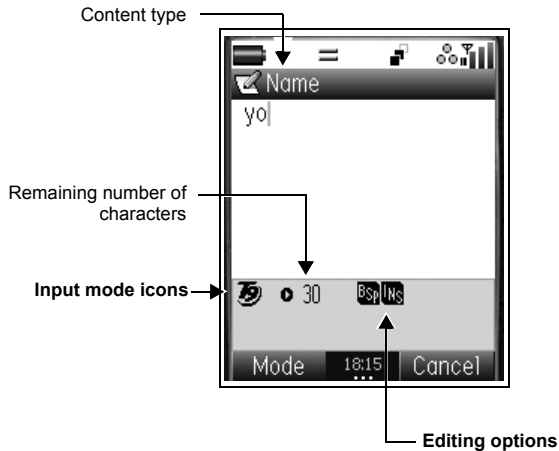

To start messaging:

Press the **SK2 (Msg)**. Or press the **MENU** key, **Messages** and press the **SK1 (New)**. (Refer to the **Writing and Sending a New Message** on page 43 for details)

To change the input mode:

Press the **Enter** key to start inputting text from the text entry field. Press **SK1 (Mode)** to select the text entry mode you require.

To change the Editing options:

Press the **Options menu** key from the text entry screen. Select **Editing options** or press **6**. Change the settings in **Editing options**.

<Input mode>	<Clear mode>	<Write mode>
Multitap input	Delete	Insert
T9® input (Predictive text)	Backspace	Overwrite
Numeric input		

Multitap Text (ABC) Input

The following example shows how to enter the word **dog** in a text message:

To	Do this
1 Enter d	Press the (3DEF) key once, then d appears.
2 Enter o	Press the (6MNO) key three times, then o appears.
3 Enter g	Press the (4GHI) key once, then g appears. Press the Right key to move to the next character position. Enter the 0 key to select and insert a space.

 Press the * key to switch lower case, upper case (shift) and Caps lock.

T9® Text Input

In the T9® text Input mode, you press each key only once, even if the character you want is not the first character on the key.

When you press the keys, different words are suggested. If the word you want is not suggested, you can edit the word and register it in the dictionary for access the next time.

The following example shows how to enter the word **fog** in a text message:

To	Do this
1 Enter fog	Press the (3DEF) (6MNO) (4GHI) keys. The word " dog " should appear.
2 Convert and select the word you want	Press the SK1 (Next) , SK2 (Prev.) or # key to display the word you want, then press the Right key to enter the displayed word or the 0 key to select and insert a space. Do this until the word " fog " appears.
3 If the word you want is not suggested, edit the word and register it by using the Multitap Input Mode	Enter fog by using the Multitap Input Mode. The word is registered in the dictionary. If you enter the (3DEF) (6MNO) (4GHI) keys the next time, you can select the word fog .

 To insert symbols and face marks, press **Options menu** and press **1** (see **Symbol input** section on page 35 for details).

 Press the * key to switch lower case, upper case (shift) and Caps lock.

Other things you can do when editing text

To Enter a Space

To enter a space in the text in the Multitap Text Input mode or the T9® text input mode, press the **0** key.

To Insert a New Line

To insert a new line in the text, move the cursor to the insertion point of the new line, press and hold the **#** key. Alternatively, press the **Options menu** key, **New line**.

To Change the Case

Press the ***** key to toggle between Shift (next letter in upper case), Caps Lock and Lower case (see diagram on page 33).

To Change to Delete/Backspace Mode

To change to delete/backspace mode, press the **Options menu** key, **Editing options**, then **Delete** or **Backspace** in **Clear mode**.

In **Delete** mode, you can delete characters after the cursor. In **Backspace** mode, you can delete characters before the cursor.

To Change to Insert/Overwrite Mode

To change to insert/overwrite mode, press the **Options menu** key, **Editing options**, then **Insert** or **Overwrite** in **Write mode**.

To Copy/Cut and Paste the Text

To	Do this
1 Activate copy/cut	Press the Options menu key in the text input mode, then select Copy/Cut .
2 Specify the copy/cut starting point	Move the cursor to the starting point by using the 4-way navigation key and press the Enter key. Note: You can cancel the specified copy/cut starting point by pressing the C key.
3 Specify the copy/cut ending point	Move the cursor to the end by using the 4-way navigation key and press the Enter key. Note: The clipboard's maximum capacity is 1024 bytes.
4 Specify the paste point	Move the cursor to the paste point by using the 4-way navigation key.
5 Paste the block	Press the Options menu key, then select Paste .



You can paste copied/cut text into other applications.

Using Messaging

Press **SK2 (Msg)** on the Home screen or press the **MENU** key → Select **Messages** or Press the 2 key.

This section describes how to work with messages:

- Overview
- Message Menus
- Writing and Sending a New Message
- Receiving and Reading a Message
- Replying and Forwarding
- Organising Messages

Overview

Message Types

Your e228 supports the following message types:

- **Text messaging**
To send a text message, the person you are calling must be a text messaging or SMS service subscriber.
- **Video messaging** allows you to send messages with multimedia files attached. Multimedia files include video clips, audio files and image files. Up to 60 attachments are allowed per message, with the total message size not exceeding 100 KB, including the message text. When you receive a video message, you are notified by a message from the message centre. You can either automatically or manually receive the contents of a video message. Video messaging is available only in 3G and 2.5G coverage.
- **Multimedia messaging** allows you to send messages as a slide show containing images, text, video and audio files. When you receive a multimedia message, you are notified by a message from the message centre. You can receive the contents of a video message (automatically or manually). Multimedia messaging is available in both 2.5G and 3G coverage.
- **Email** allows you to send messages with attachments to email addresses. Up to 60 attachments are allowed per message, with the total data size not exceeding 100 KB including the message text. Attachable files include ringtones, images, audio, video and other types of files. You can only forward these to another email address. There are two types of email server: POP3 and IMAP4. With a POP3 server, your email is received and stored in the phone, while with IMAP4 the received email is stored on the email server. The list of email in the **Remote mailbox** is synchronised with the email stored on the IMAP4 server.
The 3 Email service is available in both 2.5G and 3G coverage.



3 only allows access via IMAP4

Supported Attachment Types

The following shows the supported attachment types that can be played/used by e228 (these files can be attached to messages and transferred between your phone and PC):

- Video: MPEG4, WMV, H.263 baseline
- Audio: MIDI, MPEG4-AAC, MP3, WMA, AMR
- Image: JPEG, GIF, PNG, BMP, WBMP, TIFF (TIFF can only be forwarded)
- Text: Text, vCard, vCalendar

Message Menus

Message menu

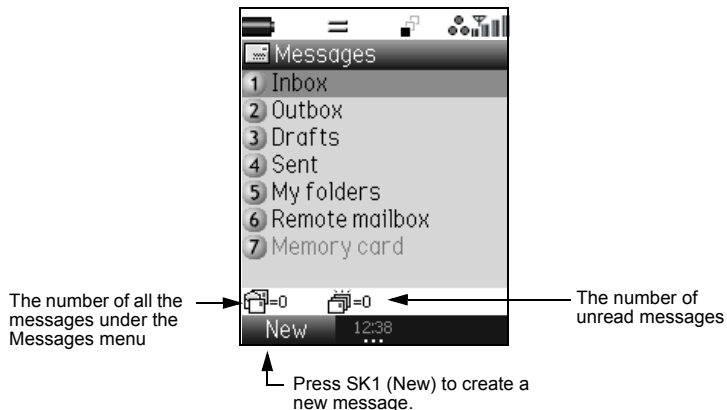

The following describes the options on the **Messages** menu list:

Item	Description
Inbox	Displays the received messages.
Outbox	Displays the messages waiting to be sent.
Drafts	Displays incomplete messages.
Sent	Displays sent messages as a list.
My folders	Displays a list of folders to store the messages. You can create up to 10 folders.
Remote mailbox	Accesses the specified email server. Up to 50 folders including the Inbox can be created in the Remote mailbox . Up to 1000 messages can be stored in the Remote mailbox .
Memory card	Accesses the messages stored in the memory card. Note: This menu is available while a memory card is inserted into the phone.

The following describes the **Options menu** provided under the **Messages** menu list by pressing Options menu key on the Messages screen.:

Item	Description
New message	Selects the message type (Text/Video/Multimedia/Email) on the next screen.
Check messages	Checks for new emails from 3 email server. The menu is available for POP3 server.
Link this	Adds a shortcut for the currently selected folder to the Home screen or Quick menu.
Delete all folders	Deletes all the messages and user-defined folders in the phone memory.
Settings	Changes the message settings (see the following descriptions for details.)

Settings menu provides **General**, **Text messages**, **Multimedia msgs** and **Email settings**. The following describes the settings provided under **Settings**:

Item	Description
General:	The following describes the settings provided under General :
Scrolling	Selects the number of lines scrolled when you press the Up or Down key. Select from Scroll one line , Scroll three lines , Scroll five lines or Scroll one page .
Display	Selects the title display in the message list. Show sender : Displays the sender's address/phone number or the sender's name as registered in your Contact list. Show the subject : Displays the subject of the message.
Heading text	Turns the automatic header insertion function on/off and edits the header sentence. Text insertion settings : When Auto insert text is set, the header sentence is automatically inserted. Setting Insert manually turns this function off. Heading text : Supports the header up to 128 characters. Enter text and press the Enter key.

Item	Description
Signature setting	<p>Turns the automatic signature insertion function on/off and edits the signature.</p> <p>Text insertion settings: When Auto insert text is set, the signature is inserted automatically. Setting Insert manually turns this function off.</p> <p>Signature text: Edits the signature up to 60 characters. Enter your text and press the Enter key.</p>
Quote indicator	Edits the quoted reply mark.
Text messages:	The following describes the settings provided under Text messages:
Send options	<p>Changes the settings for sending text messages.</p> <p>Delivery report: Selects whether to request a status report of the sent text messages. Select Request report and No report request.</p>
Validity period	<p>Selects the period of time the text message is stored on the server while trying to deliver the text message. Select 12 hours, One day, One week, One month or Maximum time.</p> <p>Note: One month is 30 days.</p>
Text msg centre	Edits the text message centre address. This address is saved in the USIM card.
Multimedia msgs:	The following describes the settings provided under Multimedia msgs:
Receive options	<p>Changes the settings for receiving multimedia messages.</p> <p>Download timing: Selects whether to receive the multimedia messages manually or automatically.</p> <p>When Manual is selected, the contents of the multimedia messages stay in the message centre until you request a download or the date has expired. You may wish to use Manual to manage the available memory: e.g., download messages once you know you have sufficient memory.</p> <p>When Automatic is selected, the e228 automatically downloads the contents of the video/multimedia messages.</p> <p>Maximum download size: Sets a maximum size of a multimedia message that the phone can receive.</p> <p>Anonymous messages: Selects whether to receive a multimedia message without a sender's ID (e.g. sender's name or telephone number) or not. Select Refuse or Accept.</p> <p>Multimedia msg playback: Selects how to play the received multimedia message when you select it and press the Enter key.</p> <p>Automatic: The multimedia message is played immediately.</p> <p>Manual: The message information is displayed. Press the Enter key to start playing.</p>

Item	Description
Send reports	Selects whether to create a delivery report and send it back on request or not. Select Send reports or No reports sent .
Validity period	Selects the period of time the multimedia message is stored on the server while trying to deliver the message. Select 12 hours , One day , One week , One month or Maximum time . Note: One month is 30 days.
MMS centre	Edits the MMS centre address. This address is saved in the USIM card.
MMS proxy	Edits the proxy server address.
Email settings for: Email server one or Email server two	The following describes the settings provided under Email : Note: 3 only allows access via IMAP4.
Server settings	Server name: Displays and edits your email server name. Server priority: Sets server priority (primary/secondary).
Server type	POP3 or IMAP4: Sets POP3 server or IMAP4 server Use APOP: Sets whether to use APOP server or not. Select Yes or No . Leave on server: Selects whether to leave the downloaded message on a POP3 email server or not. Select Leave messages or Delete messages .
Name + password	User name: Displays and edits the user name to access the email server. Password: Displays and edits the password to access the email server. Asterisks (***) are displayed.
Email address	Displays and edits your email address used in the From field when sending an email and also used as your own address in the Outbox or Sent (up to 90 characters).
Receive options	Max receive size: Sets the maximum size of an email that the phone can receive.
Send options	Message send timing: Selects whether to send an email immediately or send later. Setting Send immediately sends an email immediately and Send later stores an email message in Outbox for you to send later.
Server addresses	SMTP server: Displays and edits the SMTP server address. SMTP port: Displays and edits the SMTP port. Incoming server: Displays and edits the incoming server address. Incoming port: Displays and edits the incoming port.
Authentication	Sets whether to execute the authentication operation.

Writing and Sending a New Message

The following describes common tasks and useful tips when writing and sending a new message:

Common Tasks

New Text Message

To	Do this
1 Set message type (Text message)	<p>Press the SK2 (Msg) on the Home screen key or press the MENU key and select Messages.</p> <p>Press the SK1 (New) or press the Options menu key and select New message and press the Enter key.</p> <p>On Message type screen, select Text message and press the Enter key.</p> <p>The New message screen is displayed.</p>
2 Set the addressee	<p>Select the addressee field and press the Enter key.</p> <p>Enter the addressee's phone number and press the Enter key (you can enter up to 20 digits not including the international code +).</p> <p>Note: To search the Contact list for the addressee, press the SK2 (Find).</p>
3 Enter the message text	<p>Select the text entry field, enter the message and press the Enter key.</p>
4 Send the message	<p>Press the SK1 (Send).</p> <p>The message is sent and saved in the Sent folder.</p>

New Video Message

Up to 60 attachments are allowed per message, with the total message size not exceeding 100 KB, including the message text.

You can send video messages to compatible phones or email addresses subject to coverage availability.

To	Do this
1 Set message type (Video message)	<p>Press the SK2 (Msg) on the Home screen or press the MENU key and select Messages.</p> <p>Press the SK1 (New) key or press the Options menu key and select Video message.</p> <p>The New message screen is displayed.</p> <p>Note: You can activate the New message screen for a new video message by making a video, then pressing the Options menu, Send as message. Refer to Multimedia centre section on page 93 for details.</p>
2 Attach files	<p>Select the Attachment field and press the Enter key. Select the attachment type from Video files, Image files, Music files, Sound files and Other files and press the SK1 (OK).</p>
3 Enter the message text	<p>Select the text box and press the Enter key, enter the message and press the Enter key.</p>
4 Enter the subject	<p>Select the subject field and press the Enter key. Enter the title (up to 256 characters).</p>
5 Set the addressee	<p>Select the address box and press the Enter key. Enter the address and press the Enter key (up to 90 characters for an addressee).</p> <p>Add more addresses if necessary, by repeating the same operation for blank entries on the Address list.</p> <p>Change the address in To address to Cc (carbon copy) or Bcc (blind carbon copy) by pressing the Options menu key on the Address list and select CC address or BCC address.</p> <p>Press the SK1 (OK) to end the address list.</p> <p>Note: A total of 70 addresses can be set in TO, CC and BCC.</p> <p>Note: To set the addressee from the Contact list, press the SK2 (Find).</p>
6 Send the message	<p>Press the SK1 (Send). The message is sent and saved in Sent folder.</p>

New Multimedia Message

You can send Multimedia messages to both 2.5G, 3G phones and email addresses.



Use this function to create a slide show containing several multimedia files and message text.

To	Do this
1 Set message type (Multimedia message)	Press the SK2 (Msg) on the Home screen or press the MENU key and select Messages . Press the SK1 (New) key or press the Options menu key and select Multimedia msg . Press the Enter key on the contents entry field. Enter the message on the Edit text screen. Press the Enter key. Composer screen is displayed.
2 Compose a slide show	Press the Options menu key to use the various functions of composer. (Refer to To Edit a Slide Show on page 48 for details.) When you finish editing, press the SK1 (OK) .
3 Input the subject	Select the subject box and input the title (up to 256 characters).
4 Set the addressee	Select the address box, enter the address and press the Enter key (up to 90 characters for an addressee). Add more addresses if necessary, by repeating the same operation for blank entries in the Address list Press the SK1 (OK) to return to the New message screen. Note: You can set a total of 70 addresses in TO , CC and BCC . Note: To set the addressee from the Contact list, press the SK2 (Find) .
5 Send the message	Press the SK1 (Send) . The message is sent and saved in the Sent folder.

New Email

Up to 60 attachments are allowed per message with the total data size not exceeding 100 KB, including the message text. Attachable files include ringtones, images, audio, video and other types of files.

You can attach files such as Word, Excel, PowerPoint but you cannot read/edit these on your phone. You can only forward these. You can set a total of 70 addressees for To, Cc (carbon copy) and Bcc (blind carbon copy) fields of an email.

There are two types of Email server: POP3 and IMAP4.

With a POP3 server, your email is received and stored in the phone. With an IMAP4 server, the received email is stored on the email server, which provides the option to download the whole message or title only.

To	Do this
1 Set message type (Email)	<p>Press the SK2 (Msg) on the Home screen or press the MENU key and select Messages.</p> <p>Press the SK1 (New) key or press the Options menu key and select Email.</p> <p>The New Message screen is displayed</p>
2 Add attachment	<p>Select the attachment box and select the file type. Select a file from the list displayed.</p>
3 Enter the message text	<p>Select the message text field, enter the message and press the Enter key.</p>
4 Enter the subject	<p>Select the subject field and enter the message title up to 256 characters.</p>
5 Set the addressee	<p>Select the address box, enter the address and press the Enter key (90 characters max. for an addressee).</p> <p>Add more addresses if necessary, by repeating the same operation for a blank entry in the Address list.</p> <p>Change the address from To address to Cc (carbon copy) or Bcc (blind carbon copy) by pressing the Options menu key and selecting CC address or BCC address.</p> <p>Press the SK1 (OK) to return to the New message screen.</p> <p>Note: You can set a total of 70 addresses in TO, CC and BCC.</p> <p>Note: To set the addressee from the Contact list, press the SK2 (Find).</p>
6 Send the email	<p>Press the SK1 (Send). Your message is sent according to how you have already set the following settings:</p> <ul style="list-style-type: none"> • Send immediately for Message send timing under the Send options The email is sent and saved in the Sent folder. • Send later for Message send timing under the Send options The email is stored in the Outbox until the next time you send the message manually. Refer to Sending messages manually on page 47 for details.

Useful Tips

The availability of each function is shown by the following abbreviations:

T: Text message

V: Video message

M: Multimedia message

E: Email, **EP** is POP3 only and **EI** is IMAP4 only

Task	Steps	Available for			
Setting the addressee from the contact entries (Handset contacts)	Press the SK2 (Find) on the addressee entry box and select the addressee's phone number/email address. The selected phone number/email address is transferred in to To .	T	V	M	E
Sending messages manually	Press the Options menu key on the New/Edit message screen and select Send all and press the Enter key.				E
Previewing a message before sending	Press the Options menu key on the New/Edit message screen and select Preview message . Note: For multimedia messages, pressing the SK2 (Preview) on the Composer screen also displays the preview.	T	V	M	E
Changing the message type	Select the message type field, press the Enter key and select the message type.	T	V	M	E
Clearing the subject/address/text/attachment	Press the Options menu key and select Clear fields . Select the field to clear from Clear all fields , Clear subject (not available for text messages), Clear address , Clear text or Clear attachment (not available for multimedia messages).	(T)	V	(M)	E
Saving an unfinished and unsent message	Press the SK2 (Save) . The message is saved in Drafts .	T	V	M	E
Attaching a heading/signature	Press the Options menu key and select Insert fixed text . Select Insert heading or Insert signature .	T	V		E
Cancelling the message editing	Press the Options menu key and select Cancel editing .	T	V	M	E
Setting the priority	Press the Options menu key and select Send options . Select Message priority and set Low , Standard or High .		V	M	E
Setting the delivery date and time	Set the delivery time in the Delivery time field.		V	M	

Task	Steps	Available for		
Sending a message to multiple recipients	Select the To field on the new message screen. Press the Enter key to display the Address list . Press Options Menu key and select Add address . To add an address from the contact list, press the SK2 (Find) and select a contact to be added. Press SK1 (Use) .	V	M	E
Attaching a video, an image, an audio file or a ringtone	For video messages and email, select the attachment field on the New message screen. Press the Enter key to display the Handset memory screen. Select an attachment type folder and press Enter key. Select the attachment and press the Enter key. Press SK1 (Use) .	V	M	E
Deleting an attached file	Select the attachment field and press the Enter key. Select the attachment file name to delete. Press the Options menu key and select Delete .	V		EP

To Edit a Slide Show

You can edit the slide show for Multimedia messaging using the **Options menu** on the **Composer** screen.

Task	Steps
Changing the layout of the text	Press the Options menu key and select Text layout . Select from On top line , On top 3 lines , On top 5 lines , On bottom line , On bottom 3 lines or On bottom 5 lines . The default setting is On bottom line .
Moving a slide	Press the right/left navigation keys.
Adding a slide	Press the Options menu key and select Add slide (after) . A new slide is added after the selected slide.
Inserting a slide in between slides	Press the Options menu key and select Add slide (before) . A new slide is inserted before the selected slide.
Removing a slide	Press the Options menu key and select Delete slide .
Inserting an image/music/video/sound file	Press the Options menu key and select Insert item . Select the file type from Image , Music , Sound or Video .
Inserting/editing text	Press the Options menu key and select Insert item and then Insert text (displayed when there is no text inserted) or Edit text (displayed when text is inserted already). Input/edit text on the Edit text screen.
Deleting a text/image/audio/voice/video file	Press the Options menu key and select Remove item . Select the file type from Text , Image , Music , Sound or Video .
Setting the slide timing	Press the Options menu key and select Slide timing . The slides are displayed within the set time (one to 60 seconds).

Task	Steps
Ending the composer	Press the SK1 (OK) .
Previewing the slide show	Press the SK2 (Preview) .

Receiving and Reading a Message

 When using other applications:
If applications other than the messaging application are running when a message is received, the message ringtone does not sound but an icon is displayed on the upper area of the screen, indicating that you have an unread message. In addition, the contents of the Video message/Multimedia message are not downloaded automatically, even if the **Download timing** is set as **Automatic**, while another application is running.

 Receiving Video messages and Multimedia messages in 2G coverage
Both Video and Multimedia messaging are available in 2.5G as well as 3G coverage.

Common Tasks

To Receive a Video Message or Multimedia Message

To	Do this
1 Check the notification message	When you receive a Video message/Multimedia message, you are notified by a pop up message. The unread message icon appears on your Home screen.
2 Download the contents of the Video message/Multimedia message	When Download timing is set to Automatic (default): The contents of the Video message/Multimedia message are downloaded automatically from the message centre (when you are in 3G or 2.5G coverage). When Download timing is set to Manual : Press the SK1 (Receive) to download the contents of the Video message/Multimedia message or press the SK2 (Cancel) to receive the contents later. (Refer to To Receive a Video message/Multimedia message Manually on page 49 for details.) If cancelled, the notification message is saved in your Inbox .

To Receive a Video Message/Multimedia Message Manually

To	Do this
1 Start the messaging	Press the SK2 (Msg) . Alternatively, press the MENU key and select Messages .

To	Do this
2 Select the mailbox	Select Inbox and then select the unread message.
3 Select the notification message	Press the Enter key. To open the attachment, press SK2 (Attach.) .
4 Receive the contents of the Video message/Multimedia message	Press the SK1 (Receive) . The contents are downloaded from the message centre.

To Read a Message

To	Do this
1 Start the messaging	Press the SK2 (Msg) . Alternatively, press the MENU key and select Messages .
2 Select the mailbox to read from	Select Inbox and select the unread message.
3 Select the message	Press Enter to read the message. The message contents are displayed. Note: For a multimedia message, press the Enter key to start the slide show.

Useful Tips

For Reading a Message

The availability of each function is shown by the following abbreviations:

T: Text message

V: Video message

M: Multimedia message

E: Email, EP is POP3 only and EI is IMAP4 only

Task	Steps	Available for			
Checking newly received messages	Press the SK2 (Check) .				EP
Refreshing the current message list display	Press the Options menu key and select Update .				EI
Filtering the received messages by a condition	Press the Options menu key and select Filter view . The filters provided are as follows: Read or unread , Read messages , Unread messages , High priority , Message type , Sent or failed , Sent Later , Send failed , Video message class , Personal , Advertisements and Information . To cancel the filtering, press the Options menu key and select Show all .	T	V	M	E
Sorting the messages	Press the Options menu key and select Sort messages . The ordering available is as follows: By date ↑: Ascending order of date By date ↓: Descending order of date By subject ↑: Ascending order of subject By subject ↓: Descending order of subject	T	V	M	E
Changing the font size	Press the Options menu key and select Font size . Select Large , Medium or Small . Note: You can change the font size for multimedia messages on the Text viewer .	T	V	M	E
Switching the message list display type	Press the Options menu key and select Subject/address .	T	V	M	E

Task	Steps	Available for			
Copying or moving a message between USIM card memory and the phone memory	Select the message, press the Options menu key and select Copy or move . Select the copy/move destination, and then press the SK1 (Copy) or SK2 (Move) .	T			
Displaying the address list	Select the message, press the Options menu key and select View address list .	T	V	M	E
Displaying the attachment file list	Select the message, press the Options menu key and select View file list .	T	V	M	E
Copying or moving a message	Select the message, press the Options menu key and select Copy or move . Select the copy/move destination, and then press the SK1 (Copy) or SK2 (Move) .	T	V	M	E
Deleting a message	Select the message on the Inbox screen and press the SK2 (Delete) . Press the SK1 (Yes) to delete the message. Or select the message on the Inbox screen and press Options menu key. Select Delete and press the Enter key. Select Delete selection and press the Enter key.	T	V	M	E
Deleting all messages	Select the message, press the Options menu key and select Delete and Delete all .	T	V	M	E
Displaying detailed information on a message	Select the message, press the Options menu key and select Message details . Detailed information such as the message type and the received date and time is displayed.	T	V	M	E
Displaying various reports	Press the Options menu key and select View report .	T	V	M	
Calling back to the sender of a Text message	Display the Text message, press the Options menu key and select Call sender .	T			
Making a call to a phone number in the message text	Select the message, press the Enter key to display the message. The phone number is highlighted. (If there is more than one phone number, highlight using the Up and Down keys.) Press the Enter key. The phone number is displayed. Make a voice or video call. Note: For a multimedia message, the phone number is highlighted on the Text viewer .	T	V	M	E

Task	Steps	Available for			
Displaying a URL in the message text	<p>Select the message, press the Enter key to display the message text. The URL is highlighted. Press the Options menu key and select Open in browser.</p> <p>The browser is displayed with the selected URL.</p> <p>Note: You can also jump to the URL by pressing the Enter key with the URL address highlighted.</p> <p>Note: For a multimedia message, the URL is highlighted on the Text viewer.</p>	T	V	M	E
Adding the sender/receiver's email address to the contact list	<p>Select the message and press the Enter key. Press the Options menu key and select Add to contacts. Use Add to Contacts to save the phone number/email address. (Refer to Contacts section on page 29 for details.)</p> <p>Note: To stop the slideshow of the attachment, press the SK2 (Stop). Press Options menu key and select Add to contacts.</p>	T	V	M	E
Adding a phone number/ email address in the message text to the contact list	<p>Select the message and press the Enter key to display the message text. The phone number or email address is highlighted. (If there is more than one phone number/email address, highlight using the Up and Down keys.)</p> <p>Press the Options menu key and select Use the selection and Add to Contacts. Register the phone number/email address on Add to Contacts. (Refer to Contacts section on page 29 for details.)</p> <p>Note: For a multimedia message, a phone number/email address is highlighted on the Text viewer.</p>	T	V	M	E
Adding a URL in the message text to the Bookmarks	<p>Select the message and press the Enter key to display the message text. The URL is highlighted. (If there is more than one URL, highlight using the Up and Down keys.)</p> <p>Press the Options menu key and select Use the selection and Add to bookmark.</p> <p>Register the URL on Bookmark.</p> <p>Note: For a multimedia message, the URL is highlighted on the Text viewer.</p>	T	V	M	E

Task	Steps	Available for			
Saving an attached file	<p>Select the message and press the Enter key to display the message text.</p> <p>Select the attachment to save.</p> <p>Press the SK2 (Attach). Alternatively, press the Options menu key and select View file list to display the list of attached files and select a file to be attached, and then press the SK1 (Save) or press the Options menu key and select Save.</p>		V	M	E
Opening an attached file	<p>Select the file and press the Enter key.</p>		V	M	E

To Control the Multimedia Message Player

Task	Steps
Starting the slide show	Press the SK1 (Play) .
Pausing the slide show	While playing, press the SK1 (Pause) .
Displaying the text message	Press the Enter key.
Stopping the slide show	Press the SK2 (Stop) .

Replying and Forwarding

The following describes common tasks and useful tips when replying and forwarding.

Common Tasks

To Reply to a Received Message in Inbox

To	Do this
1 Start messaging	Press the SK2 (Msg) or press the MENU key and select Messages .
2 Display the received message to reply	Select Inbox .
3 Select message	Select and display the message to reply to.
4 Display Reply	Press the SK1 (Reply) or press the Options menu key and select Reply . Reply is displayed with the sender's address and Re: original subject for video message, multimedia message and email.
5 Input the message text	Select Message text , enter the message and press the Enter key.
6 Input the subject	If necessary, select Subject and edit the title (up to 256 characters).
7 Send the message	Press the SK1 (Send) . The message is sent and saved in the Sent folder.

To Forward a Received Message in Inbox

To	Do this
1 Start the message function	Press the SK2 (Msg) or press the MENU key and select Messages .

To	Do this
2 Display the received message to forward	Select Inbox .
3 Select the message	Select and display the message to forward.
4 Display Forward	Press the Options menu key and select Forward . Forward Message is displayed with the text contents, attached files and Fw: original subject for Multimedia messages and Video messages.
5 Set the addressee	Select To address , enter the address and press the Enter key. Note: To set the addressee from the Contact list, press the SK2 (Find) .
6 Input the subject	If necessary, select Subject and edit the title (up to 256 characters).
7 Input the message text	If necessary, select Message text , edit the message text and press the Enter key.
8 Send the message	Press the SK1 (Send) . The message is sent and saved in the Sent folder.

Useful Tips

Useful tips for replying and forwarding are shown below:

To Reply to a Received Message

Tips

Quoting from the original message when replying

You can reply to a message with quotes from the original message. Select the message and press the **Enter** key to display the message text. Press the **Options menu** key and select **Reply (with quote)**. The original message with quoted reply marks is inserted in the **Message text**.

Replying to a message with multiple addressees

You can reply to a message with multiple addressees. Select the message and press the **Enter** key to display the message text. Press the **Options menu** key, select **Reply** or **Reply (with quote)** and then select **Reply to all**.

Editing a message saved in Outbox or Drafts

Select **Outbox** or **Drafts** from **Messages**. Select the message and press the **SK1 (Edit)**.

Organising Messages

When the memory allocated for the message function is full, your e228 cannot receive new messages until you move or delete the old messages. Therefore, to prevent the message memory from being full, we recommend that you move or delete unwanted messages regularly. Or store them on a memory card, available as an optional accessory.

Creating Folders

To manage your message data, create folders under **My folders**, **Remote mailbox** or **Memory card**. You can copy/move the messages in **Inbox**, **Outbox**, **Draft**, **Sent** or **Remote mailbox** to a folder, rename the folder to indicate the category (e.g. Business, Family or Friends). Also, you can set addresses to a folder, to automatically distribute the received messages from the specified addresses.

Remote mailbox

The remote mailbox synchronises with the specified IMAP4 server to display the email list.

Under **Remote mailbox**, up to five cascading folders can be created. Folders can be created/deleted/renamed when the phone is inside the 3G coverage and communication with the IMAP4 server is possible. Press the **Options menu** key, select **New folder** and select **For messages** or **For folders**.

Synchronisation with the server starts whenever you select **Remote mailbox** on **Messages**.

Copying or Moving Messages

Copying/moving is permitted within the phone, from the remote mailbox to the phone and within the remote mailbox. Copying/moving from the phone to the remote mailbox is not supported.

When a message without the message text downloaded is included in the copying/moving target, an error message is displayed and the operation fails. When attachments are not downloaded first, a confirmation message is displayed before the operation.

Common Tasks

To Copy/Move Messages to the Memory Card

To	Do this
1 Start messaging	Press the SK2 (Msg) or press the MENU key and select Messages .
2 Select the message to copy or move	Select a mailbox and highlight the message to copy or move. Press the Options menu key and select Copy or move .
3 Select the destination	Select the mailbox/folder to copy/move the message to and press the SK1 (Copy) or SK2 (Move) . The selected message is copied or moved to the chosen destination.

To Create a Folder Under My Folders

To	Do this
1 Start messaging	Press the SK2 (Msg) or press the MENU key and select Messages .
2 Display My folders	Select My folders .
3 Create a folder	Press the SK1 (New) , and enter the folder name. A folder is created.

Useful Tips

Tips	
Deleting a folder	Select the folder and press the SK2 (Delete) or press the Options menu key and select Manage folders, Delete folder .
Renaming a folder	Select the folder, press the Options menu key and select Manage folders, Rename folder .
Registering an address for automatic distribution to a folder	Allows you to register an address to a folder you have created in the phone. Press the Options menu key and select Manage folders, Address rules . Press the SK2 (Find) to select a Contact entry and then press the SK1 (Use) . Alternatively, enter the address and press the SK1 (OK) . You can also edit the registered address rule by pressing the Options menu key and selecting Address rules .
Deleting an address/all addresses registered to automatic distribution	Press the Options menu key and select Address rules , and press the Options menu key and select Delete rule/Delete all rules .
When using a new memory card	When using a new memory card, format the card in advance. Refer to Format mem. card on page 89 for details.
Deleting all messages in the current list	To delete the whole folder, select a folder, press the Options menu key and select Manage folders, Delete folder . To delete all phone messages, press the Options menu key in Messages and select Delete all folders .

Changing the Settings on your e228

This section describes how to change the settings on your e228.

Screen image sample

Press **MENU** key → Select **Settings** icon or Press **8** → **User settings** menu (see below).

User settings menu

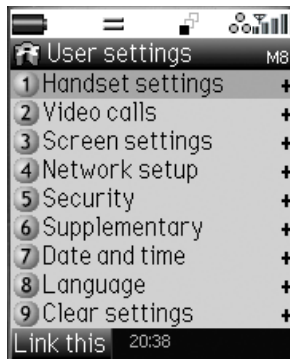

Handset Settings

(Press the **MENU** key → select **Settings** icon → select **Handset settings** or press 1 on **User settings** menu screen)

Handset settings allows you to customise the handset profile to suit different situations (handset profile) and change the settings for call time information and call options.

Handset settings menu

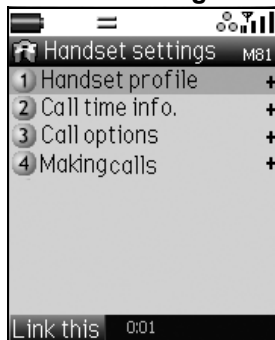

Handset profile

Handset profile allows you to change the handset operation mode to suit different situations: **Standard profile**, **Meeting profile** (quiet surroundings), **Outdoor profile** (when carrying your e228 in a pocket or a bag) and **Car profile** (while travelling in a car). Under **Select profile**, you can change the active handset profile. By changing the following settings, you can also customise each profile to make it more useful.



You can also change the active **Handset profile** from the Home Screen. Press the **Options menu** key on the Home screen and select a profile option.

Item	Description
Ring volume	Adjusts the ringing volume level from Silent to Level 6 (loud).
Ringtunes	Selects the ringtone for incoming voice calls, video calls and messages.
Illumination	Sets the illumination for voice calls, video calls and messages. Select a Pattern from three options.
Vibration pattern	Selects the vibration pattern.
Backlight	Backlight: Selects the backlight ON/OFF and brightness settings. Backlight time: Sets the backlight lighting duration between 10 and 60 seconds. The default is 15 seconds. Note: The backlight is illuminated under the following conditions: Backlight is set to on (High, Medium or Low); current profile is Car profile; the phone is being charged.
Other settings	Key tones: Turns on/off keystroke sounds. Coverage tone: Turns the coverage tone on/off. The service tone notifies that e228 is in a service area. Auto answer: Turns the auto answer function on/off. When the headset is attached, this function automatically answers the call 5 seconds after the call is first received. Valid for all incoming calls.

Call time info.

Displays and sets the call time information.

Item	Description
Current call time	Allows you to change the call time display setting. Select Current call , Outgoing calls , All calls or OFF . Under the following items, the call time information is displayed in All calls , Outgoing calls and Incoming calls .
Summary list	Displays summary information for calls.
Voice calls	Displays voice call information.
Video calls	Displays video call information.
Reset call timer	Resets the call time to zero.

Call options

Item	Description
Receiver volume	Sets the volume level for receiving calls.
Quality alarm	Turns the quality alarm on/off. This notifies you that your call may be disconnected if you move into an area where there is a weak signal. Select No alarm , Loud alarm and Soft alarm .
Any key answer	Turns the any key answer function on/off. This lets you use any key to answer a call, except for the SK2 (Ignore) , End (Reject call) , Up and Down keys.
Dial pause setting	Edits a string of keypad characters (up to 127 single-byte characters) for pause dialling. This function enables sending out of numbers while calling with pauses inserted. For example, after entering a number with the touch tone service, you can send out the numbers you entered beforehand. Pause dial entry function is useful for sending messages to a pager, etc. You can only use keypad characters (0-9, # and *) and pause (press and hold the # key: displayed as p). A pause at the beginning cannot be registered. A pause at the end is deleted when registered. Registered pause dial entry can only be used while calling. Sent out pause dial entries are not saved in the Outgoing calls list.

Item	Description
Headset	<p>Selects the ringtone output from the phone.</p> <ul style="list-style-type: none"> • Speaker rings too: Sets the ringtone to be played from both the earphones on the headset and the speaker. • Handsfree only: Sets the ringtone to be played only from the earphones. <p>When the headset is not connected to the phone, the ringtone is played from the speaker even if the phone is in Handsfree ring setting.</p>
Portrait display	<p>Displays the Caller Identification (CLI) picture in the contact list when making and receiving calls.</p>
Ignore if no ID	<p>Turns no caller ID rejection function on/off. Rejects any calls received without caller ID notification.</p>
Voicemail	<p>Sets voicemail clearance type by checking the check boxes.</p>
Making calls	
Item	Description
Send tones	<p>Turns the send tone on/off.</p>
Fixed dialling	<p>Lets you dial the set number only.</p>

Video calls

Select **Video calls** or press 2 on **User settings** menu screen

Video calls allows you to change various settings for video telephony.

Video calls menu



Camera settings

Sets the camera settings for video calls.

Item	Description
Screen mode	Selects the displayed images (other side/my side) and their screen sizes from My side is smaller , Other side only , My side is larger and My side only .
Picture quality	The quality of the image captured by e228 can be selected from Standard , Better picture (priority given to the image quality), and Faster movement (priority given to capturing movement).
Camera mode	Selects the photo mode to use for video calls from Portrait mode , Landscape mode and Night-time mode .

Video call options

Sets the video call functions.

Item	Description
Video settings	Selects the image to be sent when making a video call from Use live video and Use photo instead .
Show timer	Turns on/off the call time of the current video call.
Voice if no video	Turns the automatic fallback function on/off. This function switches to a voice call whenever a video call cannot continue for some reasons.

Screen settings

(Select “**Screen settings**” or press **3** on “**User settings**” menu screen)

Screen settings allows you to select the wake-up screen animation and the Home screen image.

Item	Description
Greeting	Power on animation: Selects the screen animation displayed when e228 is turned on. Built-in animations and captured or downloaded images can be used. Power on tone: Selects a tone that sounds when you turn on your e228. Power off image: Selects an image that is displayed when you turn off your e228.
Wallpaper	Selects the Home screen image. Note: You cannot set an image file larger than 100KB as your wallpaper.
Power save time	Sets how long your phone can remain idle before going into power save mode.

Network setup

(Select **Network setup** or press **4** on **User settings** menu screen)

Network setup settings allows you to change various settings related to the mobile phone network:

Item	Description
Network select	<p>Selects the network operator (Public Land Mobile Network, PLMN) automatically/ manually.</p> <p>When Automatic is selected, e228 automatically searches and selects PLMN in order of priority.</p> <p>When Manual is selected, a list of valid PLMNs is displayed. Select a PLMN from the list. Your e228 establishes a connection to that PLMN. If this connection is unsuccessful, a message requesting another selection is displayed.</p>
Pref.networks	<p>Displays the list of PLMNs saved in the USIM card, updates the PLMN list, adds and deletes PLMN entries, changes the access technology used for each PLMN and changes the search priority and the entry display order. USIM list can contain up to 50 PLMN entries. Add, Sort, Replace and Delete are provided under the Options menu.</p> <p>To change the search priority and the entry display order:</p> <p>Press the SK1 (Move) on PLMN List. On PLMN Priority, select the PLMN to move (selected PLMN is greyed out), move the cursor to destination and press the Enter or the SK1.</p>
Network mode	<p>Selects the mode of operation for the e228:</p> <p>Automatic: e228 automatically selects the available service.</p> <p>3G only: The service area is manually set only to the 3G coverage.</p> <p>When you are in 2G/2.5G coverage, you can change it to 3G coverage by pressing the .</p>
APN	<p>Selects and edits the Access Point Name (APN) for Always-on connection.</p>
Auto reconnect	<p>Enables automatic redialling when the first call does not connect to the other party.</p>

Security

Select **Security** or press 5 on **User settings** menu screen

Security settings allow you to turn on/off the dial lock and automatic lock. You can also change code numbers: PIN1/ PIN2, the phone code and private PIN.

Locks

Item

Description

Dial Lock

This cancels any key operation except for making emergency calls, answering a call with the Start key, rejecting a call with the End key, using the End key to turn the e228 on/off, turning off the alarm with any key and adjusting the volume of the earpiece. Note that you need a handset code to turn on/off Dial lock. Refer to **New handset code** in **Set codes** on page 68 for details on the handset code.

You can also turn **Dial lock** on/off from the Home screen. Press the **Options menu** key on the Home screen and select **Dial lock**.

Auto lock

Turns on/off the automatic lock function. With **Auto lock** on, the phone is protected by **Dial lock** automatically when you switch on your phone. After entering PIN1, the phone is locked.

Set codes

Provides code number related settings.

Item

Description

Activate PIN1

Selects Enable or Disable.

New PIN1/PIN2

Changes the PIN1/PIN2 number. Enter the current PIN, the new PIN (4-8 digits) and then the new PIN again for confirmation.

Unblock PIN1/PIN2

Displays the PIN1/PIN2 entry screen when e228 is turned on.

Note: If you enter your PIN incorrectly three times in a row, the USIM card is locked. You can unlock it by using your Personal Unlock Key (PUK). Please contact 3 for your PUK code.

New handset code

Changes the handset code required to confirm important actions, such as deleting all Contact list entries. This requires the Code Number to prevent accidental mistakes.

To change the handset code, enter a new code (4 digits), then enter the new code again for confirmation.

Note: When you buy your e228, the Code Number is set to 0000.

New private PIN

Changes the network password. Input the current password, the new password (4-8 digits) and then the new password again for confirmation.

Note: You need this password to change any call restrictions on your e228.

Supplementary

Select **Supplementary** or press 6 on **User settings** menu screen

Supplementary allows you to change settings for the following supplementary services: send my caller ID, call waiting, call forwarding, call restriction and caller ID information.

Item	Description
Send my caller ID	Sets the caller ID indication. Send notifies the receiver of your caller ID and Withhold lets you make calls without displaying your caller ID.
Call waiting	Turns the call waiting service on/off. Shows the current status of call waiting.
Call forwarding	Allows you to set up a number for forwarding calls to. Available for Voice calls/Video calls/Fax calls/Data calls . Available under these conditions: All calls/If no answer/If busy/If unreachable . Shows the current status of call forwarding. Auto check . Automatically checks for your divers.
Call restrictions	Turns the call restriction service on/off, makes an enquiry and displays the current service status. Restrict calls : Turns on the restriction service for specific types of calls provided under Outgoing/Incoming calls . Call types: Outgoing calls : All outgoing calls except emergency calls. International : Outgoing international calls. Intl. if not home : Outgoing international calls except those to the home country. Incoming calls : All incoming calls except for callback after an emergency call. Incoming + roam : Incoming calls when outside the home country. Rejects all incoming calls while roaming except for callback after an emergency call. Video calls : All video calls. Text messages : All text messages. End restriction : Turns off the service. Status : Shows the current service status. Change password : Changes the password.
Caller ID info.	Accesses the network to check the status of the current ID notification settings.

Date and time

Select **Date and time** or press 7 on **User setting** menu screen

Date and time allows you to select the date and clock display formats, set the home/dual time, time difference from GMT, turn the summer time function on/off and view the current time of both clocks.

Item	Description
Set date and time	<p>Sets Home time and Dual time settings.</p> <p>The following settings can be changed under Home time:</p> <p>Date: Sets the date for the home time. Enter month, date and year separated with the slash according to the order in Date format setting (e.g. 15/09/2003 when the Date format setting is dd/mm/yyyy).</p> <p>Time: Sets the time. Enter the current time using the 24 hour display (e.g. 2145 for 9:45 p.m.) or using the 12 hour display (e.g. PM 9:45 for 9:45 p.m.) depending on your Time format setting.</p> <p>Summer time: Sets whether the current status of the home/dual time is summer time or not. You cannot use this when your Home time is not set.</p> <p>Zone: Set the time difference between home time and GMT. Selects the city name in your home area from the Time zone list.</p> <p>Settings are available for Dual time, Summer time and Zone.</p>
Format	<p>Time format: Sets the time display format to either 12 hour display or 24 hour display.</p> <p>Clock display: Sets the clock display to either Home or Dual time.</p> <p>Date format: Sets the date display format to either dd/mm/yyyy (e.g. 15/09/2003), mm/dd/yyyy (e.g. 09/15/2003) or yyyy/mm/dd (e.g. 2003/09/15).</p>
View clocks	<p>Shows the current time for Home time and Dual time.</p>

Language

Select **Language** or press **8** on **User settings** menu screen

Language allows you to select the language for display and turn wordwrap function on/off.

Item	Description
Display Language	Selects the display language. All text in your e228 is displayed in the selected language.
Word wrap	Turns the wordwrap function in text fields on/off. Note: You cannot change Word wrap settings while an application is running.

Clear settings

(Select **Clear settings** or press **9** on **User settings** menu screen)

Clear settings function allows you to reset the settings you have made and clear the phone's memory.

 **Clear settings** is not available while an application is running.

Item	Description
Clear everything	Resets all the settings to the default settings and clears all the memory.
Clear settings	Resets all the settings to the default settings.

Using the Browser to Access the Internet

This section describes how to use the browser.

Pressing the  gives you access to a range of content, services and information from **3**. For example, viewing the latest news and weather, downloading games, checking sports results, finding locations and much more.

Browser Menus

To open a menu list, press the  and then options menu key on the browser menu screen.

The following table describes the menus:

Level 1	Level 2	Level 3	Description
Add to Contacts			Registers the highlighted phone number/email address to the Contact list. The Add contact screen is displayed with the phone number/email address inserted.
Add bookmark	Current page		Registers the displayed page to the Bookmarks. Note: Up to 50 bookmarks can be registered.
	Selected link		Registers the highlighted link to the Bookmarks.
Bookmarks			Displays the list of Bookmarks. On the list, the most recently accessed bookmark is displayed first. Press the Options menu key again to see the following submenus: Edit title: Edits the bookmark's title (24 single-byte characters). Send URL: Opens the New message screen to create a new message with the URL in the text entry field. Copy URL: Copies the bookmark's URL. Delete: Delete selection deletes the selected bookmark and Delete all deletes all the bookmarks. Link this: Adds a shortcut to the selected bookmark in the Quick menu and the Home screen.
Save page			Saves the displayed page as an offline file. Up to 20 pages can be saved. To avoid accidental deletion, you can set Protection up to 10 saved pages which are not deleted by Delete (see the following Saved pages). The maximum data size for a saved page is 100KB.

Level 1	Level 2	Level 3	Description
Saved pages			<p>Displays the list of pages saved as offline.</p> <p>Highlight a saved page title and press the Options menu key to see the following submenus:</p> <p>Edit title: Edits the saved page title (up to 24 single-byte characters).</p> <p>Send URL: Starts the message writer with the URL of the saved page in the message text.</p> <p>Protect: Protects the selected saved page.</p> <p>Unprotect: Cancels the protection of the selected saved page.</p> <p>Delete: Delete selection deletes the selected page, and Delete all deletes all the pages.</p> <p>Move to highlight a saved page title and press the Enter key to display the contents.</p> <p>When a saved page is displayed, press the Options menu key to see the following submenus:</p> <ul style="list-style-type: none"> • Add to contacts: Registers the highlighted phone number/email address/URL to the Contact list. The Add contact screen appears with the phone number/email address/URL inserted. • Save image: registers an image on the file to the Image files. • Edit title: Edits the title. • Send as message: Starts the message writer with the displayed page URL/image URL in the message text or the image file attached. • Page information: Displays the page information. Check page title displays the title. Check URL displays the URL. Check certificate displays the certificates saved with the file. Press the Enter key to start copy. Press Down key to select and the Enter at the end. Press the Enter key to end copy. • Copy as text: Copies the text on the saved page. • Protection: Sets protection on the selected file or cancels the set protection. • Delete: Deletes the selected saved page.

Level 1	Level 2	Level 3	Description
Copy as text			Copies the text on the displayed page. To start the copy, press the Enter key at the beginning. Press the Down key to select the text. Press the Enter key at the end.
Save image			Saves an image to the Image list.
Send as message	Current page URL		Open the New message screen to edit a new message with the URL of the displayed page in the message text.
	Image URL		Open the New message screen to edit a new message with the URL of the displayed image in the message text.
	Image file		Open the New message screen to edit a new message with the displayed image attached.
Refresh			Refreshes the page displayed.
Enter URL			Provides a URL entry field. You can directly enter a URL to go to the site.
History			Displays the URL history input from the Enter URL menu. Highlight a URL history and press the Options menu key to see the following submenus: Send URL: Open the New message screen to edit a new message with the URL of the selected history in the message text. Delete: Delete selection deletes the selected URL history and Delete all deletes all the URL histories.
Encoding	Latin-1		Changes the character encoding to Latin-1. Latin-1 is set by default.
	US ASCII		Changes the character encoding to US ASCII.
	UTF-8		Changes the character encoding to UTF-8.
	UCS2		Changes the character encoding to UCS2.
	UCS4		Changes the character encoding to UCS4.
	UTF-16		Changes the character encoding to UTF-16.

Level 1	Level 2	Level 3	Description
Page information	Check page title		Displays the title of the displayed page.
	Check URL		Displays the URL of the displayed page.
	Check certificate		Displays the certificate on the displayed page. When the contents of the displayed page have been downloaded without a certificate, this menu is greyed out.
Settings	Display Settings	Scroll settings	Selects the number of lines per scroll from Scroll one line , Scroll three lines , Scroll five lines and Scroll one page .
		Display settings	Images: Tick the box to enable image display. Animations: Tick the box to enable animation display.
		Font size settings	Selects the font size (small/medium/large).
	Other Settings	Cookie settings	Selects a Cookie policy from among Accept all , Block all and Prompt each time .
		Timeout	Sets the communication timeout interval: 30 seconds , 60 seconds and No timeout limit .
	Saved Pages		Selects whether to automatically save a page with/without image files or to ask each time.
	Certificates		Displays the list of certificates. When a certificate is displayed, press the SK1 (Validity) or press the Options menu key and select Change validity to enable/disable the selected certificate.
	Reset	Clear settings	Restores the default settings.
Browser reset		Restores the default condition of browser, including Saved Pages , History , Bookmarks , and Settings . Note: Refer to Set codes on page 68 for Handset code .	

Common Tasks

To End a Browser session

To	Do this
1 End a browser session	Press the End key.

To Download and Save a File in your e228 File Manager

To	Do this
1 Start the browser	Press the  . Use the Directional keys to search for a file.
2 Download the file	Select the link and press the Enter key. In accordance with the file type, the downloaded file is stored in either Video files , Image files , Music files , Sound files or Other files folders according to the file type under the Handset memory or Memory card folders. To find these folders, press the MENU key and select File manager .

To Bookmark

To	Do this
1 Access to the web page to bookmark	Start the browser and open the web page to bookmark.
2 Bookmark the page	Press the Options menu key and select Add bookmark . Note: Pressing and holding the Enter key on a highlighted link also bookmark the link..

Useful Tips

Task	Steps
Links and Anchors	<p>Pressing the Enter key on a highlighted link/anchor lets you either:</p> <ul style="list-style-type: none">• Jump to the URL• Make a voice/video call to the phone number• The link or anchor is automatically entered into the addressee field on the New message screen to create a new message• Download the multimedia file• Download the Java™ application <p>Note: To register the highlighted, press and hold the Enter key.</p>
Scrolling	<p>You can press the Up and Down keys to scroll up and down the page.</p>
Displaying the previous/next page	<p>Press the Left key to return to the previous page. Press the Right key to display the next page.</p>

Using your e228's Advanced Features

Your e228 brings you a whole new world of mobile multimedia communications!

This section describes the following advanced features of the e228:

- **Photo/Video Camera** (take pictures or record short videos and send them from your e228)
- **Multiple selections** (select multiple items in the list screens)
- **Multi-call/Multi-task** (watch the latest sports results and call your friends to tell them about it at the same time)
- **Messaging** (send text, multimedia, video messages or emails)
- Other Features of the e228 (play Java™ applications, listen to music, transfer data from a PC (Intellisync software is also available, which allows synchronisation between a PC and your e228), or store and manage your video/image/ audio data on the memory card, which is available as an accessory)

Photo/Video Camera

Ever wished you had brought your camera with you? With the e228 that won't ever happen.

When you want to show your friends what you're up to or want to ask a friend which new shirt to buy, simply take a picture and send it from your e228. To make the visual experience even more appealing, record a short video with e228 and send it by video message.

To Take and Send a Photo/Video in a Message

Refer to pages 98, 99 and 43, for details on taking photos, making videos and sending messages.

To	Do this
1 Start the image/video function	Press the SK1 (Camera) . Alternatively, press the MENU key, Multimedia centre and Take photo/Make video .
2 Take a photo/make a video clip	Press the SK1 again on the viewfinder. Alternatively, select Take photo/Make video on the Multimedia screen. The screen changes to viewfinder. Press the Enter key to start capturing.
3 Attach the snapshot/video clip to a message and send	Go into Messages and select the message type. (Refer to Writing and Sending a New Message on page 43 for details.)

Useful Tips

Make the most of your photos and video clips: send them as attachments to a message, use an image as a Home screen wallpaper, or use a photo of your friend's face as their contact picture.

Image Viewer

Using the Image Viewer, you can view photos you take using e228's camera, as well as images downloaded to your e228 or received attached to a message. Such images can be used as a home screen wallpaper or contact picture. Refer to **To View an Image File** on page 102 for details.

Video/Audio Player

You can play video and audio data saved in the e228's play list using the Video/Audio Player. Refer to **Multimedia centre** section on page 93 for details.

Multiple selections

To Select Multiple Items

In some lists, for example in **Contacts**, you can highlight multiple items by using the * and # keys. Start your selection by pressing * .

To select/deselect another item, press * .

To highlight a group of items, start the selection by pressing * , then scroll down and press #. All items between the * and # are highlighted.

To end the multiple selections, press the **C** key.

 This function is only available in certain applications. This function is not available for contacts when accessed through the **Up** or **Down** keys. The application can in this case be accessed by pressing the **MENU** key and then **5**.

Multi-call/Multi-task

Did you ever wish you could send a message while talking on the phone? e228's multi-call function lets you do this.

If you want to check your calendar while talking, the multi-task function allows you to display the calendar saved in e228.

For example, you can use one of the following functions while talking on your phone:

- Browser
- Message (text message/multimedia message/video message/email)
- Java™ application
- Contact
- Settings
- Toolbox

 The more tasks you are carrying out simultaneously, the more 'pages' you see on the multi-task icon; it could show two or three pages depending on the amount of simultaneous multi-tasking being performed by your e228.

To Start/Switch Tasks During Multitasking

To	Do this
1 Go back to the Home screen	Press the Start key.
2 Start another task	Enter the phone number to make a call. Press the MENU key and select Messages to start messaging. Press the SK2 (Contact) or Up key to start the contact list function. Press the  to access 3 multimedia services. Press the MENU key to display Main Menu .
3 Switch to another task	Press and hold the MENU key. The taskbar is displayed. Select the required task by pressing Left and Right keys and the Enter key to switch to the selected task.
4 End tasks	End a task: Select the icon on the taskbar to end and press SK1 (End task) . End all tasks: Press SK2 (End all) . When only the Home screen icon is displayed, no tasks are active. Press the End key to end multi-tasking.

High-Speed Data Communications

Your e228 supports high-speed data communication rates for your PC via a USB connection. PC Connection requires e228 PC Synchronisation and File Transfer software, as well as a USB data cable (available as an accessory). To install the software, attach the USB cable between your e228 and a PC, and install the e228 USB driver from the "Utilities/Tools" section of your e228 CD-ROM (also available as an accessory). Then to discover how this technology can be used with your e228, please refer to **Connections** section on page 107.

 **Note** The ability to use your e228 as a modem to access the Internet is an operator-dependent service. Please check with 3 to ensure that this service is available.

 **Note** A dial-up connection is possible in 3G as well as 2G coverage. However, the speed of communication is faster in 3G coverage. Please check with 3 to ensure this service is available.

Messaging

Your e228 supports four types of messaging services: Text message, Multimedia message, Video message and Email:

- **Text message** service is suitable for exchanging text messages. Refer to **Message** section on page 37 for details. Use text messaging to send a message to a colleague saying you will be 10 minutes late for a meeting or to tell a friend the movie schedule for Friday night.
- **Multimedia message** service sends a slide show of images, video, audio and text. A slide show plays a combination of multimedia files. Multimedia messaging is available in both 2.5G and 3G coverage. Refer to **Message** section on page 37 for details. Use multimedia messaging to send a slide show of a new house listing containing several photos to a client with a message or to snap a photo of a celebrity and send it to a friend.
- **Video message** is a form of Multimedia messaging and allows you to send a message with attachments: take a photo or make a video and attach it to a message. Video messaging is available both 3G and in 2.5G coverage. Refer to **Message** section on page 37 for details. Use video messaging to make a video of your product and send it to a client with a message or to send a short movie of your birthday party to a friend.
- **Email** allows you to send messages to email addresses with ringtones (MID), images (GIF, JPEG, BMP), audio (AAC, WMA), video (MPEG4) and other types of files attached. You can also cc or bcc other people on your email message. Email is available in 2.5G and 3G coverage. Refer to **New Email** on page 45 for details. Use email to receive document files attached to an email and forward them to your PC email address or to send the latest sports results to a group of friends who share the same interest.

Java™ Application

You can download Java™ applications (games, utility software, etc.) to your e228. The downloaded Java™ applications are listed in **Java™** (press the **MENU** key → select **Java™**). Up to 10 Java™ applications can be stored in your phone. If you try to download an 11th application, you must delete one of the stored applications. Refer to **Java™** section on page 90 for details.

Synchronisation

A USB cable and CD are available for the e228 as an accessory which allow PC File Transfer and Synchronisation.

Please see **Synchronisation** on page 109 for further instructions.

Memory Card

Inserting the Memory Stick Duo™, into the e228 lets you store and manage your data more easily and with much more space (up to 128MB). You can transfer the videos you recorded and the photos you took using your e228's camera on to the memory card. In addition, you can manage downloaded video/image/audio files, voice recordings, calendar entries, To Do entries and any other files you may have on your phone. Refer to **File manager** section on page 83 for details. Memory Stick Duo TM is available as an optional accessory.

Video Call (available in 3G coverage only)

If you really want to show someone what you mean, make a video call. With a video call you can not only talk but also see the other person. Ask someone for advice with a shopping decision, show someone where you are on holiday or simply show your friends how you are doing.



Video calling uses up the battery quicker than other tasks. Recharge your battery if the power is low before making a video call.



When making/receiving a video call, the phone goes into handsfree mode by default.

To make a video call to another video capable phone, refer to page 25 for details.

Using the File Manager

This section describes how to use the file manager.

You can manage all of your captured and downloaded files from here.

You can run files that have supported formats, copy, move, and sort them as well as previewing image files, and attaching files to messages. In addition, you can create uniquely-named folders to manage the files.

With a memory card inserted, either Handset memory or Memory card is available as a memory location under the **File manager**. As e228 supports Memory Stick Duo™ (see page 87), memory card status can also be checked from this menu. Please contact **3** for more information. You can also check the memory card from this menu.

 Always insert/remove the memory card with the phone switched off.

Handset memory (press the **Menu** key → select **File manager** icon → select **Handset memory**)

Handset memory shows the list of data files in the handset memory. The following shows the file categories available under **Handset memory**:

Folder	Description
Video files	<p>Downloaded and captured video files are stored here.</p> <p>Five user folders can be created under Video files with up to 100 files. The default folders are as follows:</p> <p>Downloads</p> <p>Data type: Downloaded video files with copyrighted settings Supported files: 3GP, ASF, MP4 and WMV Maximum number of files per folder: 100 (including the number of user folders) Maximum number of user folders: five</p> <p>My videos</p> <p>Data type: Captured video files and downloaded video files without copyrighted settings Supported files: 3GP, ASF, MP4 and WMV Maximum number of files per folder: 100 (including the number of user folders) Maximum number of user folders: five</p>

Folder	Description
Image files	<p>Downloaded and captured image files are stored here.</p> <p>Five user folders can be created under Image files with a total of 100 files. The default folders are as follows:</p> <p>Downloads</p> <p>Data type: Downloaded image files with copyrighted settings Supported files: BMP, WBMP, JPEG, JFIF, GIF, PNG and DCF Maximum number of files per folder: 100 (including the number of user folders) Maximum number of user folders: five</p> <p>My photos</p> <p>Data type: Captured image files and downloaded image files without copyright Supported files: BMP, WBMP, JPEG, JFIF, GIF, PNG and DCF Maximum number of files per folder: 100 (including the number of user folders) Maximum number of user folders: five</p>
Music files	<p>Downloaded audio files are stored here.</p> <p>Five user folders can be created under Music files with up to 100 files. The default folders are as follows:</p> <p>Downloads</p> <p>Data type: Downloaded audio files with copyrighted settings Supported files: WMA, MP3, AAC and MID Maximum number of files per folder: 100 (including the number of user folders) Maximum number of user folders: five</p>
Sound files	<p>Data type: Downloaded and captured voice files</p> <p>Supported files: AMR and WAV</p> <p>A maximum number of files per folder: 100 (including the number of user folders)</p> <p>Maximum number of user folders: five</p>
Other files	<p>Downloaded files with formats other than the above are stored here. Up to 100 files can be stored under this folder. No user folders can be created in this folder. vCalendar and vCard files are also stored in Other files. The default folder is as follows:</p> <p>Downloads</p> <p>Data type: Downloaded miscellaneous files with copyrighted settings Maximum number of files: 100</p>

Memory card (press the **Menu** key → select **File manager** icon → select **Memory card**)

When a memory card is inserted, **Memory card** is available under **File manager**, providing you with more space to manage your files.

 Memory card is available as an accessory. Please contact **3** for more information.

 Insert the memory card with its back facing you. Refer to **Inserting the Memory card** on page 9.

Memory card displays the list of data files on the memory card. The following shows the file categories available under **Memory card**:

Folder	Description
Video files	<p>Downloaded video files without copyrighted settings and captured video files are stored here. Captured video files are stored under My videos folder. Maximum of 100 files (including the user folders) can be stored under the Video files folder. The default folder is as follows:</p> <p>My videos</p> <p>Data type: Captured video files and downloaded video files without copyrighted settings</p> <p>Maximum number of files per folder: 100 (including the number of user folders)</p> <p>Maximum number of user folders: five</p>
Image files	<p>Downloaded image files without copyright and captured image files can be stored here. Captured image files are stored under My photos folder. Up to 100 files (including the user folders) can be stored under the Image files folder. The default folder is as follows:</p> <p>My photos</p> <p>Data type: Captured image files and downloaded image files without copyrighted settings</p> <p>Maximum number of files per folder: 100 (including the number of user folders)</p> <p>Up to five sub-folders.</p>
Music files	<p>Data type: Downloaded audio files without copyrighted settings</p> <p>Supported files: WMA, MP3, AAC and MID</p> <p>Maximum number of files per folder: 100 (including the number of user folders)</p> <p>Up to five sub-folders.</p>

Folder	Description
Sound files	Data type: Downloaded and captured voice files Supported files: AMR and WAV Maximum number of files per folder: 100 (including the number of user folders) Maximum number of user folders: five
PIM data	No files can be stored directly under PIM data . The default folders are as follows: Calendar files Data type: Calendar entries Maximum number of files: 100 To Do files: Data type: To Do entries Maximum number of files: 100
Other files	Downloaded files with formats other than the above are stored here. Up to 100 files can be stored under this folder. No user folders can be created in this folder.



The maximum number of files may change according to the memory card capacity and the actual memory usage.



Do not remove the memory card while you are displaying the folder/file list or altering a folder on the memory card. Removing the memory card while accessing a folder or files may damage the memory card and the phone.

What is Memory Stick Duo™?

Memory Stick Duo™ is a new, compact, portable and versatile IC (integrated circuit) recording medium with a data capacity that exceeds a floppy disk. Memory Stick is specially designed for exchanging and sharing digital data among Memory Stick compliant products. Because it is removable, Memory Stick Duo can also be used for external data storage.

Memory Stick is available in two sizes: standard size and compact Memory Stick Duo™ size. Once attached to a Memory Stick Duo adapter, Memory Stick Duo becomes the same physical size as the standard Memory Stick and thus can be used with products compliant with the standard Memory Stick. Memory Stick is available in various types and sizes to meet various requirements. Memory Stick Duo is the only format compatible with the e228.

 Memory Stick Duo is available as an accessory. Please contact 3 for more information.

Memory Stick Duo™ Overview

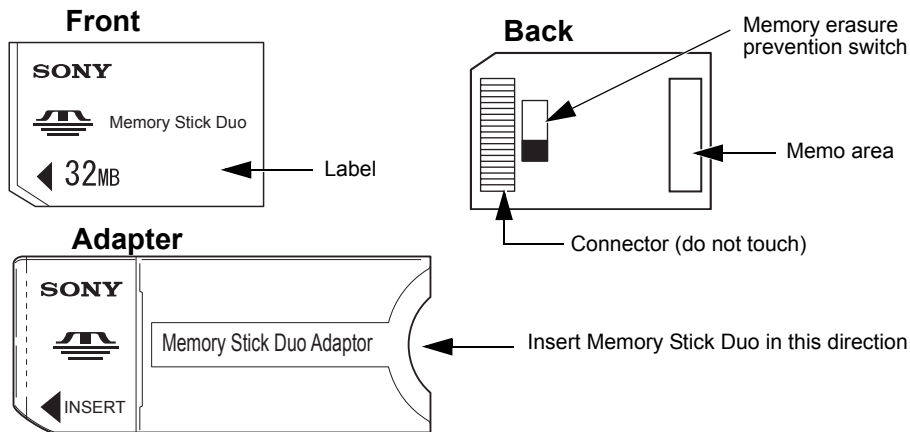

Operations

The following options are available for **File manager**

H: Available for **Handset memory**

M: Available for **Memory card**

Task	Description	Available for	
Executing a file	You can open a file by moving the highlight to the file and pressing the Enter key. For video/audio/image files, Multimedia centre is activated.	H	M
New folder menu option	Creates a new folder in either of the folders: Video files/Image files/Music files/Sound files/Other files. The default folder name starts "New". Note: Folder names must be unique.	H	M
Copy menu option	Copies the highlighted file/multiple files/folders to another folder. Note: Downloaded files can only be copied to locations within the Downloads folder. Note: Up to 100 files can be selected at one time. Note: Refer to To Select Multiple Items on page 78 for details on selecting multiple items.	H	M
Delete menu option	Deletes the highlighted file/multiple files/folders. Note: Up to 100 files can be selected at one time. Note: When an open file is included in the selected files to delete, the delete operation does not complete. Note: Refer to To Select Multiple Items on page 78 for details on selecting multiple items.	H	M
Move menu option	Moves the highlighted file/multiple files/ to another folder. Note: Downloaded files can only be moved within the Downloads folder. Note: Maximum of 100 files can be selected at one time. Note: Refer to To Select Multiple Items on page 78 for details on selecting multiple items.	H	M
Sort files menu option	Sorts the files in order of file name, file size and date. (Files are displayed in file name order by default.)	H	M
Send as message menu option	Sends the highlighted file attached to a message. Note: Downloaded files cannot be sent out as email attachments.	H	M

Task	Description	Available for	
Rename menu option	Renames the highlighted file/folder. Note: Maximum of eight single-byte characters can be specified for a file/folder name.	H	M
File properties menu option	Displays the file information of the highlighted file: date, size, title (displayed if any), file name (always displayed), attribute, copy permission and message transfer permission.	H	M
Thumbnails menu option	Switches to/from thumbnail or list display.	H	M
Switch memory menu option	Selects memory to display from Handset and Memory card .	H	M
Link this menu option	Create shortcut on the Home screen and in the Quick menu list. Select Add to Home or Add to Quick Menu . Pressing the SK1 (Link) on the list screen also creates a shortcut for the selected file.	H	M
Memory status menu option	Displays the amount of free/used memory space in the handset/ memory card in bytes.	H	M

Memory card tool

 Memory card is available as an accessory. Please contact **3** for more information.

Memory card tool provides the helpful functions on using memory card, as follows:

Item	Description
Format mem. card	Formats the memory card. Deletes all original data in the memory card, and creates empty folders for your data.
Check mem. card	Checks for data errors in the memory card.
Memory status	Displays the amount of free and used memory in both the handset and the memory card.

Running Java™ Applications

This section describes how to run Java™ applications downloaded through the browser.

Applications

Press **MENU** key → select **Java™** icon.

To Run Downloaded Applications

To	Do this
1 Select an application you want to run	Select an application from the Java™ screen and press the Enter key. Then select the file to run and press the Enter key. The application is activated. Note: Pressing the SK1 (Info.) displays the application properties. Note: You can edit the application name by pressing the SK2 (Rename) .
2 Do any of the following:	
• End the application	Press the End key.
• Pause the application	Press the C key.
• Resume the application	Press the SK1 (Resume) .
• End the paused application	Press the End key to return to the Home screen or the C key to return to the Application screen.

Pressing the **Options menu** key on the **Java™** screen displays the following items:

Item	Description
Properties	Displays properties on the selected application.
Check for update	Updates the selected application.
Edit title	Edits the name of the selected application. You can enter up to 64 single-byte characters.
Delete	Delete: Deletes the highlighted application. Note: You can select multiple applications by pressing the * key. Delete All: Deletes all the applications.

Item	Description
Set permissions	Sets the network access permission. Refer to Set permissions on page 91.
Settings	Refer to Settings on page 91.

Pressing the **Options menu** key on **Application** screen displays the following items:

Item	Description
File properties	Displays information on the selected file.
Edit name	Edits the name of the highlighted application. You can enter up to 64 single-byte characters.
Link this	<p>Add to Home: Adds a shortcut of the selected application to the Home screen.</p> <p>Add to Quick Menu: Adds a shortcut of the selected application to the Quick menu.</p>

Set permissions

To set permissions, press the **Options menu** key on Java™ screen, select the **Set permissions** and press the **Enter** key.

Set permissions provides the following options:

Item	Description
Net access	<p>Selects the phone's response to a Java™ application requesting connection to the network.</p> <p>Ask every time: Every time the application requests connection to the network, a confirmation message is required to permit access or not.</p> <p>Ask on start only: A confirmation message to permit access or not is required only once each time the application is started.</p> <p>Always permitted: Network access requested by a Java™ application is always permitted.</p> <p>Not permitted: Network access requested by a Java™ application is never permitted.</p>

Settings

To change the following settings, press the **Options menu** key and select **Settings** and press the **Enter** key..

Item	Description
Show information	Selects whether to display application properties when downloading a Java™ application or not.

Item	Description
Backlight control	User setting only: Backlight settings can be adjusted for each Handset profile. Refer to Handset profile on page 61 for details. Application control: Allows the backlight operation to be controlled through the application. It continues to be controlled by the setting on the phone unless it has been set through the application.
Vibration control	Selects which is applicable vibration settings, user setting or Application setting.

Using the Multimedia Centre

This section describes how to use your e228's multimedia centre to capture and play back multimedia files. You can also use it to play back files that have been downloaded or sent to you.



Use of MPEG4 files is restricted to non-commercial purposes.

Use of this product in any manner that complies with the MPEG-4 visual standard is prohibited, except for use directly related to

(A) Data or information encoded by a consumer for personal and non-commercial use without remuneration;

(B) Data or information (i) generated by and obtained without charge from a consumer not engaged in a business enterprise, and (ii) for personal use only; and

(C) other issues specifically and separately licensed by MPEG LA, L.L.C.

The following shows the supported file types and size:

Item	Capture file type	Player file type	Maximum file size and resolution
Video	MPEG4	MPEG4-Video, WMV, H-263	Short video: 100KB Long video: 300KB QCIF (176x144) or SubQCIF (128x96) WMV version 8 or 9. Maximum bit rate:128Kbps
Voice	AMR	AMR	60 seconds
Image	JPG	JPG, GIF, PNG, BMP, WBMP, JFIF, DCF	-100KB Inward Camera: Mail (128x96): 128 x 96 pixels CLI (120x120): 120 x 120 pixels Large (352x288): 352 x 288 pixels Outward Camera: Mail (128x96): 128 x 96 pixels CLI (120x120): 120 x 120 pixels Large (352x288): 352 x 288 pixels X large (640x480): 640 x 480 pixels

Item	Capture file type	Player file type	Maximum file size and resolution
Audio	-	MPEG4-AAC, WMA, MP3, AMR, WAV (u-law), WAV (linear)	-
	-	MIDI (SMF)	-20KB

Multimedia centre provides the following functions:

Capture:

- Camera (**Take photo**)
- Video camera (**Make video**)
- Voice recorder (**Record sound**)

Player:

- Image viewer (**View images**)
- Video player (**Play video**)
- Audio player (**Play music and Play sound**)



Pressing the **SK1 (Link this)** on **Multimedia** list screen adds a shortcut of the selected menu on the Home screen or in the Quick menu.

Capture

Image/Video Camera

Camera Capture

Do one of the following to display the image capture screen:





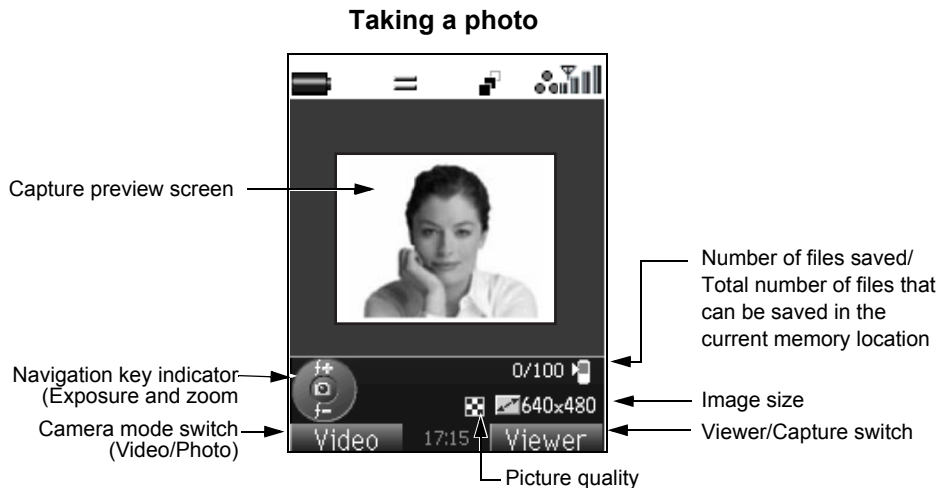











- Press the **SK1 (Camera)** from the Home screen (video capturing function is activated. Press the **SK1 (Photo)** to take a photo).
- Press the **MENU** key, select **Multimedia centre** and then **Take photo** or **Make video**.
- Select the shortcut on the Home screen or in the Quick menu and press the **Enter** key.

The following shows an example of the camera capture screen for **Take photo** with the image size set to **Mail (128x96)**:

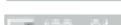

Item	Description
Navigation key indicator	Indicates what the navigation keys do. Up and Down: Adjusts exposure Right: Zoom-in Left: Zoom-out Enter: Takes picture/starts recording/stops recording Note: You cannot use the zoom function when the image size is set to Large (352x288) when using the Inward camera, or X large (640x480) when using the Outward camera.
Operation icons	Indicates the current modes of operation.
Capture preview screen	Displays a preview of the image which would be captured by the camera.
Camera setting icons	Indicates the following camera settings: Size, Picture quality, Image type, Lighting settings, Memory location, Sound settings and Self timer .

Camera Icons:

<Navigation key indicator>	<Operation mode>	<Video size>
 Start/end recording	 Portrait shot/Night scene	 100k x 144 Short video
 Take a shot	 Sunny/Cloudy/Indoors	 300k x 144 Long video
 Zoom in/Zoom out	 Economy/Standard/High	<Photo size>
 Exposure adjustment	 Video without sound	 640 x 480 X large (640x480)
	 Video recording	 352 x 288 Large (352x288)
	 Self timer on	 128 x 96 Mail (128x96)
	 Handset memory or Memory card	 120 x 120 CLI (120 x 120)

Camera Options menu

Item	Description
Switch camera	Switches between Inward/Outward camera.
Size	Selects photo size and video file size. Photo size Mail (128x96): 128 x 96 pixels. Suitable for email attachment CLI (120x120): 120 x 120 pixels. Suitable for CLI picture Large (352x288): 352 x 288 pixels X large (640x480): 640 x 480 pixels (Outward Camera Only) Video file size Short video: Sets the video size to 100KB. Long video: Sets the video size to 300KB.
Picture quality	Selects the image quality. Economy: Low image quality to keep the data size small Standard: Normal image quality High: High image quality
Image type	Selects the photo shooting mode. Landscape view: Standard setting Portrait shot: Suitable for taking photos of people Night scene: Suitable for taking photos at night
Memory settings	Memory location: Selects the location to save image/video files. Select Memory card or Handset memory . Memory status: Displays the number of image/video files that can be stored.
Self timer (only for photos)	Turns the self timer function on/off. When the self timer is turned on, a photo is taken after 10 seconds.
Sound settings (only for videos)	Turns on/off the sound recording while making video. Select Video with sound or Video only .
Lighting settings	Changes the setting according to the light conditions. Sunny: Suitable for taking photos outdoors, on a sunny day Cloudy: Suitable for taking photos outdoors on an overcast day Automatic: The camera automatically detects the current lighting level and adjusts the settings Indoors: Suitable for taking photos indoors

Camera Settings

Item	Description
Recording mode	Switches the photo/video capture function when you press the SK1 (Photo/Video) .
Zoom setting	Turns the zoom function on/off when you press the Right or Left key. Note: You cannot use the zoom function when the image size is set to Large (352x288) when using the Inward camera, or X large (640x480) when using the Outward camera.
Exposure setting	Changes the exposure rate when you press the Up and Down keys.

To Take a Photo

- 1 Press the **SK1 (Camera)** from the Home screen and press the **SK1 (Photo)** or select **Take photo** from **Multimedia centre**. Press the **Enter** key to take a photo. When the self timer is turned on, a photo is taken after 10 seconds. You can change the following settings:

To	Do this
Switch camera	Press the Options menu key and select Switch camera to switch between Inward/Outward cameras.
Zoom in/out	Turn the zoom function on/off by pressing the Right or Left key. Note: You cannot use the zoom function when the image size is set to Large (352x288) when using Inward camera, or X large (640x480) when using Outward camera.
Adjust the exposure rate	Press the Up and Down keys to adjust the exposure rate.
Use the Options menus	Refer to Camera Options menu on page 97 for details.

- 2 After taking a photo, the capture completion screen appears. You can do the following from this screen:

To	Do this
Send the file attached to a Multimedia message/Email	Press the SK1 (Send) . Note: Refer to Writing and Sending a New Message on page 43 for details.
Return to the capture preview to take a new photo	Press the SK2 (Back) .
Use the Options menus <ul style="list-style-type: none">• Rename the file	Press the Options menu key and select Rename .

To	Do this
<ul style="list-style-type: none"> Delete the file 	Press the Options menu key and select Delete .
<ul style="list-style-type: none"> Send the file as a message 	Press the Options menu key and select Send as message .

To Make a Video

- 1 Press the **SK1 (Camera)** from the Home screen or select **Make video** on **Multimedia centre**. Press the **Enter** key to start recording. You can change the following settings:

To	Do this
Switch camera	Press the Options menu key and select Switch camera to switch between Inward/Outward cameras.
Switch camera (while recording)	Press the SK2 (In/Out) to switch between Inward/Outward cameras. In: Camera facing inward, i.e. the display side Out: Camera facing outward
Zoom in/out	Press the Right key to zoom in or Left key to zoom out.
Adjust the exposure rate	Press the Up and Down keys to adjust the exposure rate.
Use the Options menus	Refer to Camera Options menu on page 97 for details.

- 2 Press the **Enter** key to stop recording. After making a video, the capture completion screen appears. You can do the following from this screen:

To	Do this
Send the file attached to a Multimedia message/Email	Press the SK1 (Send) . Note: Refer to Writing and Sending a New Message on page 43 for details.
Return to the capture preview to make a new video	Press the SK2 (Back) .
Use the Options menus	
<ul style="list-style-type: none"> Rename the file 	Press the Options menu key and select Rename .
<ul style="list-style-type: none"> Delete the file 	Press the Options menu key and select Delete .
<ul style="list-style-type: none"> Send the file as a message 	Press the Options menu key and select Send as message .

Voice Recorder

The voice recorder feature allows you to record a message while you are not online. The recording time is 60 seconds. The recorded voice is automatically saved as an AMR file which can be attached to a multimedia message/email.

The following Options menus are provided to **Record sound**:

Item	Description
Recording start screen	
Memory settings	Memory location: Selects the destination of the saved voice file. Select Memory card or Handset memory . Memory status: Displays the number of audio files that can be stored, memory used, memory available and the number of free file slots.
Multimedia centre	Activates the Multimedia Player.
Recording complete screen	
Rename	Edits the file name for the recorded voice.
Delete	Deletes the recorded voice.
Send as message	Sends the file attached to a message.

To Record Sound

- 1 Do one of the following to display the voice recorder:
 - Select **Record sound** on **Multimedia centre** screen.
 - Select **Play sound**, a sound file and press the **SK2 (Record)**.
 - Select the shortcut on the Home screen or in the Quick menu and press the **Enter** key.
- 2 Press the **Enter** key to start recording.
- 3 Press the **Enter** key again to stop the recording.
- 4 On the recording complete screen, press the **SK1 (Send)** to send the recorded voice file attached to a multimedia message/email or the **SK2 (Back)** to return to the recording start screen.

Player

The following shows an example of the player screen:

Playing/viewing multimedia files

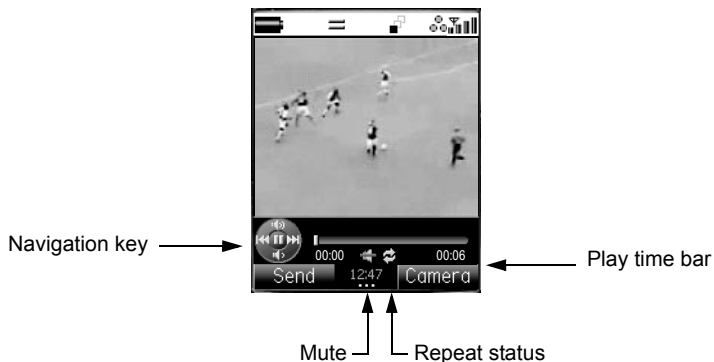

Image viewer

The image viewer function of **Multimedia centre** allows you to view JPG, GIF, PNG, BMP, WBMP, JFIF and DCF image files. The image files can be captured by the phone, downloaded from a browser or received attached to a message. You can choose to view either one particular image file or several image files registered in a playlist.

The following Options menus are available for **View images**:

Item	Description
Select file	Selects the file type and then the file to play.
Playlist	Selects the playlist.
Set as wallpaper	Sets the selected image as wallpaper. If the animation GIF is displayed, this option cannot be selected. The following image files are available for setting: JPG, PNG and GIF and the file size is 100KB max.

Item	Description
Visual effects	Apply visual effects to the displayed image. Select Negative image , Sepia tone , Mirror image , Soften image , Sharpen image or Emboss . If the animation GIF is displayed, this option cannot be selected. Press the SK1 (Save) to save the change to the image or the SK2 (Undo) to cancel the change. Note: Visual effects is not available when the image is CLI (120x120) size. Neither is it available when a Mail (128x96) size image is displayed in Small (176x144) display setting.
Image settings	Slideshow timing: Sets the interval between each image for one to 30 seconds. During the slideshow, the SK1 (Pause) or SK2 (Play) is available. Display settings: Selects to display the image in Default size or Fit to screen . Repeat settings: Turns the repeat function on/off and selects the repeat target. Select Repeat on or Repeat off . This function repeats the playlists on the View image .
Rename	Edits the file name.
File properties	Displays information about the file
Delete	Deletes the selected file.

To View an Image File

To	Do this
1 Choose to play a file or a playlist	Select View images and press the Enter key.
2 Select an image file/playlist	
3 Do any of the following	
• Display the next file	Press the Right key.
• Display the previous file	Press the Left key.
• Attach the file to a message	Press the SK1 (Send) . Note: The SK1 (Send) is greyed out when the attached file is 100 KB or larger.
• Edit the file name	Press the Options menu key and select Rename .
• End View image	Press the Clear key.

Video player

The Play video in **Multimedia centre** allows you to play MPEG4, AAC, AMR, WMV and H.263 video files captured by the phone, downloaded from a browser or received attached to a message. You can choose to play either one particular video file or several video files registered in a playlist.



If you download a file using the browser or receive/send a message while playing video, the sound may be interrupted.

The following Options menus are available for **Play video**:

Item	Description
Select file	Selects the file type and then the file to play.
Playlist	Selects the playlist.
Video Settings	Changes the video settings. WOW surround : Turns the surround sound function on/off. Select Surround on or Surround off . Repeat settings : Turns the repeat function on/off and selects the file to be repeated. Select Repeat on or Repeat off .
Mute settings	Turns the mute function on/off. This function turns off e228's speaker and the headset.
Rename	Edits the file name.
File properties	Displays information about the file
Delete	Deletes the selected file.

To Play a Video File

To	Do this
1 Choose to play a file or a playlist	Select Play video and press the Enter key.
2 Select a video file or a playlist	
3 Do any of the following:	
• Pause the video	Press the Enter key. Note : Some files cannot be paused.
• Stop the video	Press and hold the Enter key while playing.
• Fast forward	Press and hold the Right key while playing or pausing. Note : Some files cannot be fast forwarded.
• Rewind	Press and hold the Left key while playing or pausing. Note : Some files cannot be rewound.

To	Do this
• Skip to the next file	Press the Right key.
• Skip to the previous file	Press the Left key.
• Repeat	Press the Options menu key and select Repeat settings, Repeat on .
• Control the sound volume	Press the Up and Down keys.
• Send the video file as a message	Press the SK1 (Send) . Note: The SK1 (Send) is greyed out when the attached file is 100 KB or larger.
• Display the file/playlist information	Press the Options menu key and select File properties .

 To replay a file from the beginning after you start playing, press the **Left** key. Note that you can only do this if the play time is two seconds or more.

Audio player

You can play AAC, WMA, MP3, WAV (u-law), WAV (linear), MIDI and AMR audio files downloaded from a browser or received attached to a message and saved in the phone memory or in the memory card. You can choose to play either one particular audio file or several audio files registered in a playlist, using the headset connected to the phone if you wish.

 If you download a file using the browser or receive/send a message while playing audio, the sound may be interrupted.

 The **SK1 (Send)** is greyed out when you attach more than 100 KB audio file.

 You cannot play MIDI audio files larger than 20 KB.

The following Options menus are available for **Play music** and **Play sound**:

Item	Description
Select file	Selects the file type and then the file to play.
Playlist	Selects the playlist.
Music Settings	Changes the audio settings: WOW surround : Turns the surround sound function on/off. Note: Surround setting under Voice settings is not available. Repeat settings: Turns the repeat function on/off and selects the repeat target. Select Repeat on or Repeat off . Change animation: Selects the image to display while playing music files.

Item	Description
Mute settings	Turns on/off the e228's speaker and the headset.
Ringtone	Changes the ringtone settings for each phone mode: Meeting profile , Standard profile , Outdoor profile and Car profile . Ringtones are available in each mode for Voice call , Message received and Video call . Note: There is no ringtone available for Play Voice.
Rename	Edits the file name.
File properties	Displays the file information.
Delete	Deletes the selected file.

To Play an Audio File

To	Do this
1 Choose to play a file or a playlist	Select Play music and press the Enter key. Select Select file or Playlist .
2 Select an audio file or a playlist	Select the audio file or playlist you want to play and press the Enter key.
3 Do any of the following:	
<ul style="list-style-type: none"> • Pause the audio 	Press the Enter key. Note: Some files cannot be paused.
<ul style="list-style-type: none"> • Stop the audio 	Press and hold the Enter key while playing.
<ul style="list-style-type: none"> • Fast forward 	Press and hold the Right key while playing or pausing. Note: Some files cannot be fast forwarded.
<ul style="list-style-type: none"> • Rewind 	Press and hold the Left key while playing or pausing. Note: Some files cannot be rewind.
<ul style="list-style-type: none"> • Skip to the next file 	Press the Right key.
<ul style="list-style-type: none"> • Skip to the previous file 	Press the Left key.
<ul style="list-style-type: none"> • Repeat 	Press the Options menu key and select Music settings , Repeat settings , Repeat on .
<ul style="list-style-type: none"> • Control the sound volume 	Press the Up and Down keys.
<ul style="list-style-type: none"> • Send the audio file as a message 	Press the Options menu key and select Send as message .

- Display the file/playlist information Press the **Options menu** key and select **Property**.



To replay a file from the beginning after you start playing, press the **Left** key. Note that you can only do this if the play time is two seconds or more.

Playlists

You can create a list of images, video or audio files to play successively and save them as a playlist. You can create 20 playlists, each containing up to 20 files in the phone memory and 50 playlists, each containing up to 100 files in the memory card. The memory card is available as an accessory. You can add a new playlist by pressing the **SK1 (Add)**. In addition, you can display either the phone or the memory card playlists by pressing the **SK2 (phone/Card)**.

The following operations are available for the playlists under **View image**, **Play video**, **Play music** and **Play sound**:

Item	Description
Add new playlist	Adds a new playlist when you press the SK1 (Add) or select Add new playlist from the Options menu .
Edit playlist	Adds a file to a playlist or deletes a file from a playlist. Select Edit playlist from the Options menu and press the SK1 (Add) to add a file or SK2 (Delete) to delete a file.
Switch memory	Switches the playlist screens between the phone memory and the memory card.
Edit playlist name	Edits the highlighted file name in the playlists.
Delete	Deletes the selected playlists. If no playlist is available, Delete cannot be selected.
Delete all	Deletes all the playlists. If no playlist is available, Delete all cannot be selected.

In addition, the following submenus are available for playlists in each of the options above: **Add file**, **File properties** (displaying the file information depending on the file type), **Sort playlist files** (ascending or descending order **By name** ↑/↓, **By date** ↑/↓ and **By size** ↑/↓), **Move file**, **Delete** and **Delete all**.

Connecting your e228 to a PC

Press the **MENU** key → Select **External connection**

This section describes how to connect your e228 to a PC using a USB cable and PC software CD, available as optional accessories from 3. Through this interface, you can establish a dial-up connection to the PC to access the Internet. Also, by using the USB connection, you can synchronise and transfer data between your e228 and the PC. For more information please see the Software Manual in the CD-ROM available as an accessory.

 Check that your operator allows use of your e228 as a modem to connect to the internet. Please contact 3 for further details.

 The USB driver, which is available as an accessory, needs to be installed on the PC before the USB cable can be used. The following items are described in this section:

USB

USB is a simple method of connecting your e228 to a PC through a cable to achieve fast data transfer rates.

Connecting your e228 to a PC with a USB cable enables the PC to use your e228 just like a modem to establish a dial-up connection to an Internet Service Provider. When used in 3G coverage, the USB connection may provide a much faster transfer rate than a standard modem.

A USB connection also enables data transfer between your e228 and a PC. Refer to **To Transfer Data between the phone and a PC** on page 109 for details.

A USB connection can also be used to synchronise your Contacts, Calendar and To Do list between your e228 and PC.

 Your e228 may not be supplied with a USB cable or PC Synchronisation and Transfer software. These are available as accessories.

 When using the USB cable for the first time, ensure the USB Drivers are installed. See the Software Manual on the CD-ROM for further instructions.

 Check that your operator allows use of your e228 as a modem to connect to the Internet. Please contact 3 for further details.

To Establish a Dial-up Connection to a PC using a USB Cable

Do the following on your e228:

To	Do this
1 Connect the e228 and the PC with a USB cable	Insert the USB cable to the I/O connector of the e228 and the USB hub on the PC. Note: The USB cable for the e228 is available as an optional accessory from 3. Note: Insert the USB cable vertically to the e228 (do not insert it at an angle).
2 Dial up	From the PC application, start the dial-up. A connection is established.
3 Disconnect	Disconnect from the PC application.

Do the following on the PC:

 Please ensure your e228 and the PC are connected via USB cable before proceeding.

To	Do this
1 Add a new connection on PC	Using Microsoft Dial-Up Networking, add a new connection ensuring the device used to make the connection is the NEC e228 Modem. Also ensure that the telephone number to dial is set to *99# Note: This procedure only needs to be performed once.
2 Dial	Connect using this dial-up connection
3 Start the Internet communication	After connection is made, start up and use the appropriate Internet application (browser, mailer, instant messenger, etc.)

Data exchange

Data exchange is used to allow the transfer of data files between the phone memory (internal or external memory stick) and a PC.

To use this functionality, you must first install the 228 PC File Transfer Tool. To install the software, refer to the Software manual on the optional CD-ROM accessory.

 You cannot use any other applications while data is being exchanged between your e228 and a PC.

 Please note that certain recurring appointments are not supported by this phone and as such may not be created on the phone during data exchange.

To activate Data Exchange

Press **Menu** key → select **External connection** → **USB**

To Transfer Data between the phone and a PC



You can only do this from your PC.

To	Do this
1 Connect your e228 and the PC	Insert the USB cable to the I/O connector of your e228 and a USB port on the PC.
2 Activate data exchange function	Press the MENU key → select External connection → USB → Handset memory/Memory card .
3 Run PC File Transfer Tool	Start the 228 PC File Transfer Tool application on the PC.
4 Transfer data between your e228 and the PC	See the 228 PC File Transfer Tool section in the Software Manual on the optional CD-ROM (available as an accessory) for specific instructions.

Synchronisation

It is possible to synchronise your Calendar, Contacts and To Do lists locally between your e228 and a PC using a USB cable or remotely over-the-air with a **3** server.

Before attempting synchronisation, it is necessary to install the 'Intellisync' software onto your PC. The CD and USB cable are both available as optional accessories.

Intellisync software is supported by Intellisync Corporation. For further instructions on Intellisync software, visit their web site: <http://www.pumatech.com>

Please check that over-the-air synchronisation is supported by your service provider - contact **3** for further details.

Contacts are treated as vCard files and Calendar and To Do list entries as vCalendar files.

To perform local USB synchronisation

Optional CD-ROM is necessary. This is available as an accessory and contains a software manual with all necessary instructions.

To perform OTA remote synchronisation

To perform over-the-air remote synchronisation with a "**3**" server, follow the steps below:

To	Do this
1 Start the connection	Press the MENU key → External connection → Synchronisation .

To	Do this
2 Start synchronisation	Select the remote server to synchronise, press the SK1 (Start) . The selected data is synchronised between your e228 and the remote "3" server.
3 End synchronisation	When the synchronisation is complete, the function ends. Note: You can cancel the synchronisation operation by pressing the End key.

 Please check that this service is supported by your service provider - contact 3 for further details.

Synchronisation Options

Press the **MENU** key → **External connection** → **Synchronisation** → Select a Server → Press 'Options menu' key.

Item	Description
Synchronise	Starts the synchronisation of updated data with the selected server.
Server settings	Displays the synchronisation server settings for the selected server.
Synchronise all	Starts the synchronisation of all data with the selected server.
Copy settings	Copies the settings of the selected server and starts a new server setting screen on the next vacant server entry.
Delete	Deletes the selected server information. When Server one to Server six is selected, this operation returns the settings to the default values.

 Please check that this service is supported by your service provider - contact 3 for further details.

To Register a Server

The NEC e228 allows you to set up and synchronise with servers other than the default local and remote servers already present. Up to 10 servers can be registered.

To do this, follow the steps below:

To	Do this
1 Start up the connection function	Press the MENU key → External connection → select Synchronisation .
2 Select a server	Select from Server one to Server ten or rename an existing server to create a new entry.

3 Configure the synchronisation settings

Press the **SK2 (Settings)**. On **Sync. settings** screen, set the server information: **Profile name**, **Server name**, **Authentication**, **User database**, **Server database**, **Synchronisation method**, **User name**, **Password**, **Internet User name** and **Internet password**. For details see below.



Please check that this service is supported by your service provider - contact **3** for further details.

Synchronisation Settings

Press the **MENU** key → **External connection** → **Synchronisation** → Select a Server → press **SK2 (Settings)**

An explanation of the different server settings is detailed below:

Item	Description
Profile name	Sets the profile name. Server one to Server ten are displayed as default names (with no settings).
Server name	Sets the server name. The server name is equivalent to "URL of 3 Sync Server" for the Intellisync setting.
Authentication	Enables/disables the authentication method. Set Entered by user to enable user entry on the authentication screen.
User name	Sets the user name.
Password	Sets the password.
User database	Selects the server database from Contacts , Calendar or To Do .
Server database	Sets the server database name.
Synchronisation method	Sets the synchronisation method.
Internet user name	Sets the Internet server user name.
Internet password	Sets the Internet server password.



Please check that this service is supported by your service provider - contact **3** for further details.

Server one to Server six

For **Server name**, **User database**, **Server database** and **Synchronisation method**, **Servers one to six** have their own default values that are configured to perform specific synchronisation operations, as follows:

- **Server one:** "3" Sync server and Contacts
- **Server two:** "3" Sync server and Calendar
- **Server three:** "3" Sync server and To Do
- **Server four:** Local USB and Contacts
- **Server five:** Local USB and Calendar
- **Server six:** Local USB and To Do



Please check that this service is supported by your service provider - contact **3** for further details.

Using the Toolbox

This section describes how to use your e228 to help manage your time and tasks.

You can use your e228 at home or work as a calendar with appointments and to do lists, as an alarm clock, as a calculator and much more. There are six features available in the Toolbox:

Toolbox menu

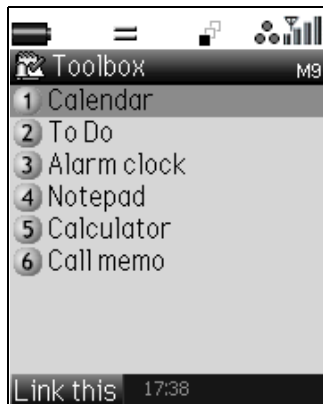

Press the SK1 (Link this) to create a link to the Home screen or the Quick menu.

Calendar (press "MENU" key → select "Toolbox" → select "Calendar")

You can save up to 200 calendar entries, ranging from appointments, multiday events, special occasions and days off. A multiday event is an event which lasts for two days or more.

Calendar

To display the calendar, press the **MENU** key and select **Toolbox** and **Calendar**.

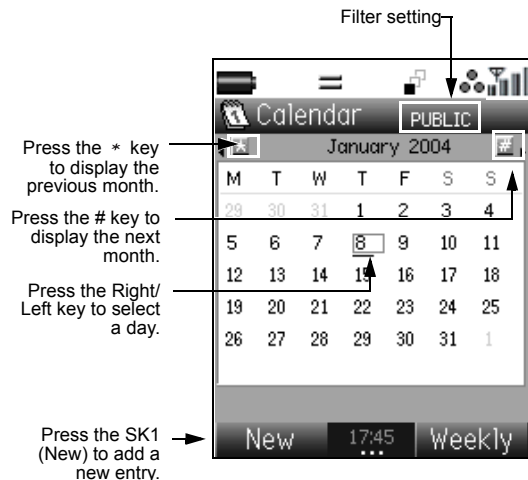

To display a day view

- Select the date you want to display on the **Weekly** or **Monthly** screen and press the **Enter** key.
- Press the **Options** menu key on the **Weekly** or **Monthly** screen. Select **Jump to date** and press the **Enter** key. Enter the date you want to display according to the **Format** setting in the **Date and time** on page 70.

The Calendar screen shows all entries for the selected date.

To add a new calendar entry

To add a new calendar entry, press the **SK1 (New)** from the **Monthly** or **Weekly** screen or press the **Options menu** key and select **New**. You can store the following types of calendar entries, an appointment, a multiday event a special occasion or a holiday (Days off).

To	Do this
1 Select the entry type	Select the event type from Appointment , Special occasion , Multiday event or Days off . Press the Enter key.
2 Do one of the following according to the entry type: <ul style="list-style-type: none">Set the Appointment items (You must enter information marked with a *.)	<p>Filter view: Selects the appointment type from Public or Private. Press the Enter key.</p> <p>Contents*: Enter the contents (up to 150 single-byte characters) and press the Enter key.</p> <p>Date*: Enter the start date according to the Format setting of the Date and time on page 70.</p> <p>Start time*: Enter the start time.</p> <p>End time: Enter the end time.</p> <p>Reminder: Turn this on to remind you of the appointment and press the Enter key.</p> <p>Alarm: Select the reminder alarm you want and press the Enter key. You can hear the tune by selecting the tune name and pressing the SK1 (Play).</p> <p>Reminder time: Set the time you want to receive the reminder and press the Enter key.</p> <p>Repeat: Set this item if the calendar entry is recurring. Select the cycle to repeat from Off, Monthly or Weekly and press the Enter key.</p> <p>Note: Off indicates the appointment is non-recurring. Monthly is used to set a particular date in the month. An earlier date is set for the month without the date specified (e.g. When 31 is specified, 28 is set in February). Weekly is used to set days of week. Select one or more days using the Enter key.</p>

- Set the **Special occasion** items
(You must enter information marked with a *.)

Filter view: Select the filter type from **Public** or **Private**. Press the **Enter** key.

Contents*: Enter the contents (up to 150 single-byte characters) and press the **Enter** key.

Date*: Enter the date.

Reminder: Turn this on to remind you of the special occasion and press the **Enter** key.

Alarm: Select the clock alarm tune you want and press the **Enter** key. You can hear the tune by selecting the tune name and pressing the **SK1 (Play)**.

Reminder date: Set the day on which you want to receive the reminder and press the **Enter** key.

Reminder time: Enter the time for reminder.

Repeat: This item is set if the special occasion is recurring. Select the cycle to repeat from **Off**, **Monthly** and **Yearly** and press the **Enter** key.

Note: **Off** indicates the special occasion item is non-recurring.

Monthly is used to set a particular date in the month.

An earlier date is set for the month without the date specified (e.g. When 31 is specified, 28 is set in February).

Yearly is used to set a particular date in the year.

An earlier date is set for the year without the date specified (e.g. When February 29 is specified for 2004, February 28 is set in 2005).

- Set the **Multiday event** items
(You must enter information marked with a *.)

Filter view: Select the filter type from **Public** or **Private**. Press the **Enter** key.

Contents*: Enter the contents (up to 150 single-byte characters) and press the **Enter** key.

Start date*: Enter the start date.

End date: Enter the end date.

- Set the **Days off** items

Select entering unit from **Public holidays** or **Weekly days off** and press the **SK1 (OK)**.

Public holidays: Enter the day and press the **SK1 (OK)**.

Weekly days off: Used to set days of week. Select one or more days using the **SK1 (OK)**. Saturday and Sunday are set as default.

- 3 End the editing

Press the **SK1 (OK)** to end the editing. The **Calendar** screen shows all the entries set for the selected date.



When **Reminder** is turned on, the alarm goes off at the set time. However if you turn it off from the days appointment or special occasion before the set time, the reminder is cancelled and the alarm does not go off. To reset it, open the appointment or special occasion and set the **Reminder** to on.

Useful Tips

You can use an old entry as a template to create a new entry. Select the entry you want to copy in the **Day** screen or display the **Detail** screen. Press the **Options menu** key, select **Copy** and press the **Enter** key. Proceed as described in **To add a new calendar entry**.

To edit a calendar entry

You may wish to edit an appointment, for example, by changing the time or contents.

To	Do this
1 Select an entry	On the day appointment or special occasion list screen, press the Options menu key, select Edit and press the Enter key . When displaying the detail screen, you can also press the SK1 (Edit) key.
2 Edit an entry	Select an item you want to change and edit it.

To synchronise calendar entries between e228 and a PC

You can convert calendar entries stored in the phone to vCalendar format for transferring between the e228 and a PC. You can also use the Intellisync PC software to synchronise your calendar with your PC.

To	Do this
1 Convert the selected entry to vCalendar format	In the entry Detail screen, press the Options menu key and select Synchronisation and vCalendar . Select the location in which the vCalendar file to be stored from Handset memory and Memory card . The vCalendar format data is stored in Other files folder in the selected memory location.
2 Synchronise calendar entries	Press the Options menu key and select Synchronisation and then Synchronisation again. Synchronisation function starts up. Follow the instructions in page 109.

To delete a calendar entry or entries

To	Do this
1 Delete a calendar entry	Select the calendar entry you want to delete and press the Enter key. Press the Options menu key, select Delete , Delete event and press the Enter key. Select This event and press the Enter key.
To delete all the calendar entries	Press the Options menu key, select Delete , Delete event and press the Enter key. Select Delete all and press the Enter key. Note: When displaying all events or the personal calendar, you can select the calendar entries to delete from ALL , PRIV , or PUBLIC . When displaying the public calendar, you can delete only the public calendar entries.
To delete all the calendar entries up to the specific date	Press the Options menu key, select Delete , Delete event and press the Enter key. Select Up to date and press the Enter key. Select ALL , PRIV , or PUBLIC and then the date. Note: When displaying all events or the personal calendar, you can select the calendar entries to delete from ALL , PRIV , or PUBLIC . When displaying the public calendar, you can delete only the public calendar entries.
2 Delete a holiday	Select Days off in the Day view screen and press the Enter key. Press the Options menu key, select Delete , Delete day off and press the Enter key. Select This day off and press the Enter key.
To delete all the holidays up to the selected date	Press the Options menu key, select Delete , Delete day off and press the Enter key. Select Up to date , press the Enter key and select the day.
To reset holidays to the default settings	To reset holidays to the default settings (only Saturdays and Sundays are set as holidays), press the Options menu key, select Delete , Delete day off and press the Enter key. Select Reset days off and press the Enter key.

To Do (press "MENU" key → select "Toolbox" → select "To Do")

This feature allows you to set up To Do tasks that should be finished by a certain date. You can save up to 200 To Do entries.

To Add a New To Do Task

In **To Do list**, press the **SK1 (New)**, or press the **Options menu** key and select **New** to open the new task screen. Press the **Enter** key on each field to select and edit.

Adding a new task 1/2

Enter a title, or the first 32 characters from the content are displayed as the title automatically.

Edit content. You can enter up to 150 single-byte characters.

Enter the done date if the To Do task is completed. If you enter a date here, the status changes to **Done** automatically.

The screenshot shows a 'New task' dialog box with the following fields and controls:

- Category:** A dropdown menu currently set to 'Personal'.
- Title:** A text input field.
- Contents:** A larger text input field.
- Deadline:** A date selection field.
- Priority:** A dropdown menu currently set to 'Normal'.
- Status:** A dropdown menu currently set to 'To Do'.
- Done date:** A date selection field.
- Buttons:** 'OK', '19:53' (time), and 'Cancel' at the bottom.

Select a category.

Set due date.

Select priority.

Set the task status, **To Do** or **Done**. If you select **Done**, the current date is entered in the Done date field automatically.

Adding a new task 2/2



Useful Tips

You can use an old To Do task as a template to create a new task. Select the task you want to copy on **To Do list** or display the **Detail** screen. Press the **Options menu** key, select **Copy** and press the **Enter** key. Proceed as described in **To Add a New To Do task**.

To Edit To Do Tasks

You may wish to edit a task, for example, by changing the due date or the status. To edit a task, select the task to edit, press for the **Options menu** key. Select **Edit** and press the **Enter** key. When displaying the **Details** screen, you can also press the **SK1 (Edit)**. Select an item you want to change and edit. Follow the instructions in **To Add a New To Do Task** other than the following:

To	Do this
1 Set the day when the To Do event was completed	Select Done date and press the Enter key. Enter the date when the To Do event is completed according to the Day display format setting of the Date and time on page 70. Note: This automatically changes the To Do task status to Done.
2 Change the status to Done	Select the status box and press the Enter key. Select To Do or Done and press the Enter key. Note: This automatically sets the current date to the Done date.

To Delete To Do Tasks

To	Do this
Delete this event	Select a task from To Do List or Filter List and press the Options menu key. Select Delete, This event and press the Enter key.
Delete all the completed tasks	Press the Options menu key and select Delete, Delete done tasks and press the Enter key.
Delete all the tasks	Press the Options menu key, select Delete, Delete all and press the Enter key.

Useful Tips

When you select **To Do**, you are presented with the **To Do list** which lists all tasks (both finished and unfinished) in chronological order. You can filter the To do list to display only the To Do entries for a particular status or category.

To set the filtering conditions, press the **Options menu** key, select **Filter view** and press the **Enter** key. Select To Do box and press the **Enter** key. Follow these instructions:

To	Do this
1 Set the list condition by selecting To Do task status to display	Select status of To Do tasks you want to display from To Do , Done or All and press the Enter key.
2 Set the sort criteria	Select the criteria by which you want to sort To Do tasks: Deadline or Priority and press the Enter key.
3 Set the category	Select the category you want to display: All , Personal , Office , Study , Travel , Shopping , Preparations , Sport , Housework or Other . Press the Enter key.

Alarm clock

Press **MENU** key → select **Toolbox** → select **Alarm clock**

To Set an Alarm

Select the alarm clock to set up to 5 alarms from **Alarm 1** to **Alarm 5** and press the **Enter** key, or press the **SK1 (Edit)**. You can set a recurring alarm to ring at a specific time on several days of week. The Alarm tone will only sound if the phone is switched on.

Setting alarm

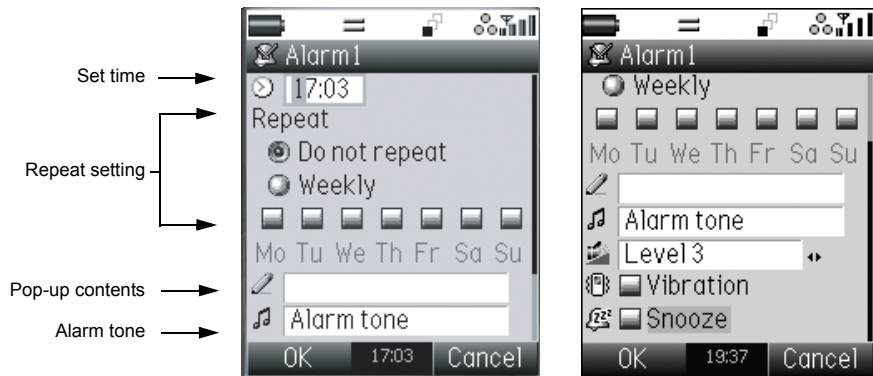

To	Do this
1 Set time	Set the time using the 24 hour display and press the Enter key.
2 Set repeat setting	Select one of the following cycles and press the Enter key: Do not repeat or Weekly . Do not repeat indicates does not repeat. Weekly is used to set days of week. Select one or more days using the Enter key. Note: Disabling Weekly Alarm disables the next immediate occurrence of this weekly alarm only. See To Change alarm clock status on page 125.
3 Enter pop-up contents	Enter contents (up to 32 single-byte characters) to be displayed in the pop-up window on the set time screen and press the Enter key.
4 Set clock alarm tone	Select the tone you want and press the Enter key. You can hear the tone by selecting its name and pressing the SK1 (Play) .
5 Set clock alarm volume	Select the volume you want and press the Enter key.
6 Set clock alarm vibration and snooze	Check/uncheck the Vibration and Snooze checkboxes using the Enter key. When the alarm goes off, and snooze is set, sound and vibration occur at five minute intervals. This happens up to three times unless you turn off either snooze or the alarm clock.
7 Fix the settings in the alarm entry	Press the SK1 (OK) . The alarm is set to on. Note: Make sure that you set alarm to on. To change it, press the SK2 (On/Off/Disable) . Refer to To Change alarm clock status on page 125.

Useful Tips

- When the alarm and vibrate go off, press the **SK1 (Turn off)** to stop the alarm.
- When the alarm goes off and you have set snooze, do any of the following:
 - To stop the alarm clock and cancel snooze, press the **SK2 (Off)**.
 - To snooze, press the **SK1 (Snooze)**. After five minutes, the alarm clock goes off again.
 - To let the alarm continue, do nothing.. After three minutes, the snooze screen is displayed. To stop the alarm at this point, press the **SK2 (Cancel)**. If you do not press any more keys, the alarm clock goes off again after five minutes. The alarm clock goes off up to three times in all, unless you stop snooze or the alarm clock.

To Edit an Alarm

To edit your alarm clock setting, press the **SK1 (Edit)** and edit. Follow the instructions in **To Set an Alarm** on page 123.

To Change alarm clock status

You can change alarm clock status on/off/disable on the Alarm clock list screen. Select an alarm on the list and do the following:

To	Do this
1 Set alarm clock status	To change the alarm clock status from On to Disable , press the SK2 (Disable) . To change the alarm clock status from On to Off , press the SK2 twice (SK2 (Disable) -> SK2 (Off)) Disable cancels the next alarm but does not cancel a recurring alarm. Off deactivates the set alarm.

To Delete Alarms

To	Do this
Delete an alarm	Select an alarm clock from Alarm1 to Alarm5 . Press the Options menu , select Delete and press the Enter key. Select Delete and press the Enter key.
Delete all the alarms	Press the Options menu , select Delete and press the Enter key. Select Delete all and press the Enter key.

Notepad

Press **MENU** key → select **Toolbox** → select **Notepad**

The Notepad feature allows you to keep notes and other useful information, such as agendas and minutes of meetings, shopping lists and other items you need to remember. You can save up to 9 text notes.

To Create a New Notepad Entry

To	Do this
1 Select an empty entry	Select No contents and press the SK1 (New) or Enter key.
2 Enter a title	Enter a title (up to 32 single-byte characters including spaces) and press the Enter key. Note: You cannot start a new line in the title.
3 Enter contents	Enter a text message (up to 512 single-byte characters) and press the Enter key.

Useful Tips

You can add your notepad entries to your Calendar or To Do task by copying and pasting. (The first 150 characters can be pasted.) Select a notepad entry you want to copy and press the **Options menu** key. Select **Calendar item** or **To Do item** and press the **Enter** key. Follow the instructions in **To add a new calendar entry** on page 115 or **To Add a New To Do Task** on page 119.

You can also start the message writer from **Notepad** to send your notepad entry as a message. Select a notepad entry you want to send as an email and press the **Options menu** key. Select **Send as message** and press the **Enter** key. Refer to **Writing and Sending a New Message** on page 43.

To Edit a Notepad Entry

To	Do this
1 Select the notepad entry you want to edit	Select a notepad entry from the list and press the Options menu key. Select Edit and press the Enter key.
2 Edit the title	Select Note title and press the Enter key. Enter a title (up to 32 single-byte characters including spaces) and press the Enter key. Note: You cannot start a new line in the title. Note: When the title is omitted, the first 32 characters from the contents are entered as a title automatically.

To**Do this**

3 Edit contents

Select **Note contents** and press the **Enter** key.

Edit a text message (up to 512 single-byte characters) and press the **Enter** key.

Note: You can save the notepad entry by pressing **SK1 (Save)**.

To Delete a Notepad Entry**To****Do this**

Delete a notepad entry

Select a notepad entry from the list and press the **Options menu** key. Select **Delete**, then **Delete** again. Press **SK1 (Yes)** on the confirmation screen.

Delete all the notepad entries

Press the **Options menu** key, select **Delete, Delete all**. Press the **SK1 (Yes)** on the caution screen to delete all the notepads.

Calculator

Press **MENU** key → select **Toolbox** → select **Calculator**

Calculator

Your e228 has a built-in calculator, which can add, subtract, divide and multiply. Use the following keys:

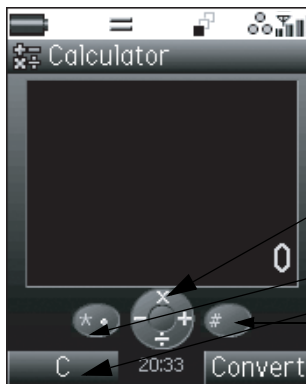

- Use the **Right** key as + key
- Use the **Left** key as - key
- Use the **Up** key as × key
- Use the **Down** key as / key
- Use the **Enter** key as = key
- Use the * key to enter a decimal point
- Use the **SK1** as the AC key or to clear the figure
- Use the **#** key as +/- switch key
- Use the **SK2** to switch to the currency converter

To Use the Calculator

In this example, we are going to multiply 10.5 by 10.

To	Do this
1 Enter 10.5	Press 1 , 0 , * and 5 keys.
2 Multiply	Press the Up key.
3 Enter 10	Press 1 and 0 keys.
4 Get the answer	Press the Enter key.
5 Clear the display	Press the SK1 .



When switching from the currency converter to the calculator, the cash amount value of the currency converter is displayed in the totals area of the calculator unless the currency calculation result is displayed.

Currency Calculation

This feature allows you to convert an amount of money in one currency to another currency by using either the exchange rate which is built in or one you enter.

To Convert one Currency to Another

In this example, we are going to convert 100 Pounds Sterling to Euros.

Press **SK2 (Convert/Calc)** to switch between the Calculator and the Currency converter.

To	Do this
1 Enter amount of money	Select Amount and enter 100 .
2 Select the base currency	Open From: select GBP .
3 Select the currency to convert to	Open To: and select EUR .
4 Modify exchange rate	Press the Options menu key and select Set rate and enter the rate in Rate . Press SK1 (OK) .
5 Get calculation result	Press the SK1 (Result) .

Useful Tips

- You can choose your currency by using the **Left** or **Right** key in the **From:** and **To:** fields on the **Convert Currency** screen.
- You can set currency rates by pressing the **Options menu** key and selecting **Set rate**. Edit the name of the listed currency by pressing the **Options menu** key and selecting **Edit name**.

Call memo

Press **MENU** key → select **Toolbox** → select **Call memo**

The Call memo feature allows you to record a short audio message (up to 20 seconds) during a call. You can use a Call memo to temporarily store phone numbers, addresses or reminders. You can save up to five call memos in your e228.



To record a call memo during a call, press the **Options menu** key and select **Call memo** to start recording the conversation.



You cannot attach a call memo to messages or copy them to the memory card.

To Listen to a Call Memo

To	Do this
1 Select a call memo to play	Select a call memo to play on the Call memo screen.
2 Start playing	Press the SK1 (Play) .

To Delete a Call Memo

To	Do this
1 Select a call memo to delete	Select a call memo to delete on the Call memo screen.
2 Delete	Press the SK2 (Delete) .

Shortcut Keys

Shortcut keys can help you access some things more easily. The following table shows the shortcut keys that are available and explains what you can use them for in various modes. The word "long" means pressing and holding a key.

Mode	Key	Function
In Home screen	SK1	Activates the camera function
	SK2	Activates the Messaging function
	Up	Displays the Contact list
	Down	Displays the Contact list
	Left	Incoming calls list
	Right	Missed calls list
	Start	Outgoing calls list
	Enter	Activates the desktop
	Triangle	Activates the browser
	Triangle (long)	Switches to 3G coverage Note: Available only when Dual USIM is inserted and you are in 2G coverage.
	MENU	Displays Main Menu
	MENU (long)	Displays the taskbar
	End (long)	Power off
	0 (long)	Enters + for international call
Options menu	Displays the Options menu list	

Mode	Key	Function
While dialling	SK1	Makes a video call to the entered number
	SK2	Saves the entered number to the contact list
	UP	Moves the cursor up
	Down	Moves the cursor down
	Left	Moves the cursor to the left
	Right	Moves the cursor to the right
	Start	Makes a voice call to the entered number
	Triangle	Activates the browser
	MENU	Displays the Main Menu
	MENU (long)	Displays the taskbar
	End	Returns to standby mode
	End (long)	Power off
	C	Deletes one digit
	C (long)	Repeats deletion
	0 (long)	Enters + for international calls
# (long)	Enters p (pause)	
Options menu	Displays the Options menu list	
While receiving	SK1	Answers the call
	SK2	Rejects the call
	MENU	Displays the Main Menu
	MENU (long)	Displays the taskbar
	Start	Answers the call
	End	Rejects a call
	End (long)	Rejects a call and turns the power off
	Options menu	Displays the Options menu list
	C	Mutes the ringtone
	Other than above	Answers a call (when Any key answer is on)

Mode	Key	Function
During a call	SK1	Holds the call
	SK2	Displays the Contact list
	Up	Turns the volume up
	Down	Turns the volume down
	Left	Incoming calls list
	Right	Missed calls list
	Start	Outgoing calls list
	Start (long)	Switches handsfree on/off
	Triangle	Activates the browser
	MENU	Displays the Main Menu/Quick menu
	MENU (long)	Displays the taskbar
	End	Ends the call
	End (long)	Ends the call and turns the power off
	0 (long)	Enters + for international calls
	Options menu	Displays the Options menu list

Mode	Key	Function
Text entry using multitap mode	SK1	Switches to numeric mode (and, if pressed again, switches to T9® mode)
	SK2	Cancels text editing
	Options menu	Displays the Options menus
	Enter	Completes text editing
	Start	Returns to the Home screen
	End	Discards the text and closes messages
	End (long)	Power off
	C	Characters remain in the text box: Deletes one character to the left of the cursor No character is in the text box: Cancels the deletion and returns to the saved data
	C (long)	In Delete mode: Deletes all the characters after the cursor In Backspace mode: Deletes all the characters before the cursor
	0-9 (long)	Enters 0-9
	1	Inserts symbols
	0	Inserts a space
	#	Displays the symbol menu
# (long)	Starts a new line	
*	Specifies the character and switches between lower case, shift and caps lock mode	

Mode	Key	Function
Text entry using T9® mode	SK1	No unconfirmed entry: Switches to Multitap mode (and, if pressed again, switches to numeric mode) Unconfirmed entry: Displays the next T9 combination
	SK2	No unconfirmed entry: Quits text editing Unconfirmed entry: Displays the previous T9 combination Last combination: Go back to the previous combination
	Options menu	Displays the Options menu
	Enter	Completes text editing and closes the editing text screen
	Start	Returns to the Home screen
	End	Discards the text and closes messages
	End (long)	Power off
	C	Characters remain in the text box: Deletes one character to the left of the cursor No character is in the text box: Ends the text entry screen
	C (long)	In Delete mode: Deletes all the characters after the cursor In Backspace mode: Deletes all the characters before the cursor
	0-9 (long)	Enters 0-9
	0	Enters +
	#	Displays the symbol menu that can insert a symbol
	# (long)	Starts a new line
*	Specifies the character and switches between lower case, shift and caps lock mode	

Mode	Key	Function
Text entry using numeric mode	SK1	Switches to T9® mode (and then, if pressed again, switches to Multitap mode)
	SK2	Cancels text editing
	Options menu	Displays the Options menus
	Enter	Completes text editing and closes the text editing screen
	Start	Returns to the Home screen
	End	Discards the text editing and closes the message function
	End (long)	Power off
	C	Characters remain in the text box: Deletes one character to the left of the cursor No character is in the text box: Cancels the deletion and return to the saved data
	C (long)	In Delete mode: Deletes all the characters after the cursor In Backspace mode: Deletes all the characters before the cursor
	0-9	Enters 0-9
	0 (long)	Inserts +
# (long)	Starts a new line	

Index

A

Activate PIN1 68
Alarm clock 123
Any key answer 62
APN 67

Appointment 114

Attachment types 38

Audio player 104

Auto lock 68

Auto reconnect 67

B

Battery 7

Bookmarks 72

Browser 72

C

Calculator 128

Calendar 114

Call forwarding 69

Call logs 20

Call memo 24

Call options 62

Call restrictions 69

Call time information 62

Call waiting 69

Caller ID info. 69

Calling Line Identification (CLI) 21

Camera 27, 78, 94

Camera mode 27, 65

Certificate 75

Charging 7

Check memory card 89

Clock 12

Clock format 70

Contact group 29

Contacts 29

Copy/cut and paste 36

Currency converter 129

D

Days off 114

Delete/backspace mode 36

Dial lock 68

Display 4

Drafts 39

Dual time 70

E

Earpiece volume 24

Email 37, 81

Email server one/two 42

Emergency call 18, 28

Exposure setting 98

F

File manager 83

Fixed dialling 63

Folder 57, 83

Format memory card 89

G
GPRS 1
Greeting 66
Group talk 24
H
Handset code 68
Handset memory 83
Handset profile 61
Handset settings 60
Handsfree call 27
Heading/signature 47
Headset ringing 63
Home screen 4, 15
Home time 70
I
Icon list 13
Ignore call if no ID 63
Image quality 27
Image type 97
Image viewer 101
IMAP4 42
Inbox 39
Incoming + roam 69
Incoming calls 20, 26
Incoming calls list 19
Insert/overwrite mode 36
International call 19
J
Java™ 81, 90
K
Key lock 28

Keys 3
L
Language setting 71
Lighting settings 97
Locks 68
Low battery alarm 8
M
Main menu 13
Making calls 63
Memory card 9, 85
Memory card tool 89
Memory Stick Duo™ 9
Menu list 13
Messages 39
Microphone on/off 27
Missed calls 20, 26
Missed calls list 19
Mode indicator 4
Multi-call 79
Multi-day event 114
Multimedia message 37, 81
Multimedia Message Player 55
Multiple selections 79
Multitap text input 34
Multi-task 79
My folders 39
N
Network mode 67
Network select 67
New line 36
Nickname 29

Notepad 126
Numeric input 35
O
On hold 24
Options menu list 13
Outbox 39
Outgoing calls 20
Outgoing calls list 19
Own number 12
P
Pause dial 20
Photo 98
Picture quality 65, 97
PIM data 86
PIN 68
PIN code 12
Player 101
Playlist 106
POP3 42
Portrait display 63
Power on/off 11
Power save time 66
Power saver 12
Pref. networks 67
Private PIN 68
Private schedule 115
Public schedule 115
Q
Quick menu 15
Quote 41

R
Remote mailbox 39, 57
Ring volume 61
S
Saved pages 73
Scratchpad 24
Screen mode 65
Second call 23
Security settings 68
Self timer 97
Send reports 42
Send tones 63
Sent box 39
Show timer 65
Signature 41
Slide show 48
SMTP port 42
SMTP server 42
Snooze 124
Space 36
Special occasion 114
Speed dial 19
Status indicator 4
Sub-address 20
Supplementary 69
Switching cameras 97, 98, 99
Symbol input 35
Synchronisation 81, 109
T
T9 text input 34
Taskbar 17, 80

Text edit 36
Text message 37, 81
Third call 25
To Do Task 119
U
UMTS 1
USB 107
USIM Card 5
V
Video 99
Video call 25, 78
video call 82
Video call options 64
Video call settings 64
Video camera 94
Video message 37, 81
Video player 103
Visual effects 102
Voice call 18
Voice recorder 100
Voicemail 22, 63
W
Wallpaper 66
Z
Zone 70
Zoom 98

v1.3
MDS-000054-EAA0
June 2004 1st edition